

PROMOTIONAL SIGNS & DISPLAYS

PANNEAUX ET AFFICHAGES PROMOTIONNELS



CATALOGUE

2024























INDEX

	page
1. POSTER FRAMES AND DISPLAYS <i>Porta poster e Espositori</i> <i>Marcos para Póster y Expositores</i> <i>Cadres et présentoirs d'affiches</i>	10
1.1 Snap Frames <i>Cornici a scatto</i> <i>Marco para Póster</i> <i>Cadres Clic Clac</i>	14
1.2 Poster Frames <i>Porta poster</i> <i>Marco para Póster</i> <i>Cadres Poster</i>	22
1.3 Poster Displays <i>Espositori</i> <i>Porta Póster</i> <i>Panneaux d'Affichage</i>	26
1.4 Appendo Cable Systems <i>Porta poster con cavetti Appendo</i> <i>Sistemas de Cable Appendo</i> <i>Systèmes de Câblage Appendo</i>	34
2. TEXTILE FRAMES <i>Cornici per tessuto</i> <i>Marco Textil</i> <i>Cadres Textiles</i>	36
2.1 Textile Frames <i>Cornici per tessuto</i> <i>Marco Textil</i> <i>Cadres Textiles</i>	40
3. ILLUMINATED DISPLAYS <i>Espositori illuminati</i> <i>Tótems Publicitarios con Luz</i> <i>Displays Illuminés</i>	48
3.1 LED Poster Frames <i>Porta poster a LED</i> <i>Marcos para Póster LED</i> <i>Cadres LED pour Posters</i>	50
3.2 Lightboxes & Illuminated Totems <i>Cassonetti e totem luminosi</i> <i>Caja de luz y Tótems Luminosos</i> <i>Caissons et Totems Lumineux</i>	56
4. DIGITAL DISPLAYS <i>Espositori Digitali</i> <i>Pantallas Digitales</i> <i>Afficheurs Digitales</i>	62
4.1 Digital Displays <i>Espositori Digitali</i> <i>Pantallas Digitales</i> <i>Afficheurs Digitales</i>	66
4.2 Screen Holders and Tablet Holders <i>Supporti per schermi e tablet</i> <i>Soportes para Pantallas y Tablets</i> <i>Supports pour écrans et tablettes</i>	78

		page
5. PAVEMENT SIGNS <i>Espositori per marciapiedi</i> <i>Señales de Pavimento</i> <i>Chevalets de Trottoir</i>		82
5.1 A-Boards <i>Cavalletti</i> <i>Caballette Publicitario</i> <i>Stop-Trottoir</i>		84
5.2 Windtalkers <i>Windtalkers</i> <i>Paneles Involcables Exterior</i> <i>Stop-Trottoir</i>		92
6. LEAFLET AND CATALOGUE HOLDERS <i>Porta cataloghi e porta informazioni</i> <i>Portafolletos y Catálogos</i> <i>Porte-dépliants et Catalogues</i>		96
6.1 Leaflet and Catalogue Holders <i>Porta cataloghi e porta informazioni</i> <i>Portafolletos y Catálogos</i> <i>Porte-dépliants et Catalogues</i>		98
7. WOODEN SIGNS <i>Espositori in legno</i> <i>Carteles en Madera</i> <i>Panneaux en Bois</i>		108
7.1 Wooden Chalk A-Boards <i>Cavalletti in legno con lavagna</i> <i>Caballetes de Madera</i> <i>Stop-trottoirs en Bois pour Craie</i>		110
7.2 Wooden Chalk Boards <i>Cavalletti in legno con lavagna</i> <i>Pizarra de Sobremesa</i>		115
7.3 Dessus de Table en Bois <i>Porta informazioni da tavolo in legno</i> <i>Tischaufsteller Holz</i> <i>Houten Tafeldisplay</i>		119
8. MENU DISPLAYS <i>Porta Menu</i> <i>Porta Menú</i> <i>Affichages de Menu</i>		122
8.1 Menu Displays <i>Espositori per menu</i> <i>Porta Menú</i> <i>Affichages de Menu</i>		124
8.2 Menu Table Tops <i>Portamenù da tavolo</i> <i>Porta Menú de Mesa</i> <i>Présentoirs de Menus pour Tables</i>		134
9. OUTDOOR EQUIPMENT <i>Prodotti per uso esterno</i> <i>Equipamiento para Exterior</i> <i>Équipement Extérieur</i>		140
9.1 Outdoor Equipment <i>Prodotti per uso esterno</i> <i>Equipamiento para Exterior</i> <i>Équipement Extérieur</i>		142

		page
10. LOCKABLE NOTICE BOARDS <i>Bacheche con serratura</i> <i>Tablones de anuncios con cerradura</i> <i>Tableaux d'affichage verrouillables</i>		148
10.1 Indoor Lockable Notice Boards <i>Bacheche con serratura da interno</i> <i>Tablones de anuncios de interior con cerradura</i> <i>Tableaux d'affichage intérieurs avec système de verrouillage</i>		152
10.2 Outdoor Lockable Notice Boards <i>Bacheche con serratura da esterno</i> <i>Tablones de anuncios de exterior con cerradura</i> <i>Tableaux d'affichage extérieurs avec système de verrouillage</i>		158
11. FLIPCHARTS AND WRITABLE BOARDS <i>Flipcharts e lavagne riscrivibili</i> <i>Flipcharts y Pizarras</i> <i>Tableaux à feuilles mobiles et tableaux inscriptibles</i>		164
11.1 Flipcharts <i>Flipcharts</i> <i>Flipcharts</i> <i>Tableaux à feuilles mobiles</i>		166
11.2 Whiteboards and Pin Boards <i>Lavagne riscrivibili e per puntine</i> <i>Pizarras Blancas y Tableros de Anuncios</i> <i>Tableaux Blancs et Tableaux d'Affichage</i>		167
11.3 Accessories <i>Accessori</i> <i>Accesorios</i> <i>Accessoires</i>		174
12. WAYFINDING SYSTEMS <i>Sistemi di orientamento</i> <i>Sistemas de Orientación</i> <i>Systèmes d'orientation</i>		176
12.1 Wayfinding Systems <i>Sistemi di orientamento</i> <i>Sistemas de Orientación</i> <i>Systèmes d'Orientation</i>		178
12.2 Barriers <i>Barriere</i> <i>Barreras</i> <i>Barrières</i>		180
13. GLASS SHOWCASES <i>Bacheche di vetro</i> <i>Vitrinas en Vidrio</i> <i>Vitrines en Verre</i>		186
13.1 Glass Showcases <i>Bacheche di vetro</i> <i>Vitrinas en Vidrio</i> <i>Vitrines en Verre</i>		188

LEGEND

 Writable surface	 Graphic with zipper
 For indoor use	 Graphic with Velcro
 For covered outdoor use	 Silicone Edge Graphic
 For outdoor use	 1-foot banner
 For double-sided use	 2-foot banner
 For single-sided use	 No feet banner
 Connectable	 Height adjustable
 Backlit illuminated	 For landscape placement
 Lights as option	 For portrait placement
 Including trolley	 B1 certificate
 Including carrying bag	 WiFi connection
 This product is lockable	 USB slot
 IP56 resistance*	 Other colours on request
 IP54 resistance*	 Other sizes on request
 IP53 resistance*	 Conformité Européenne
 Ultra High Definition (4K) Screen	 Full High Definition Screen
 Plug & Play	 +50°/-30° C
 20° Angle	 Touch function
 MagicINFO Cloud	 Bluetooth
 Including Wheels	 2 Years Warranty
 Samsung Screen	 Tempered Glass
 Delivered on a Pallet	

* IP53 is protected from limited dust ingress and water spray less than 60 degrees from vertical
 * IP54 is protected from limited dust ingress and water spray from any direction
 * IP56 is protected from limited dust ingress and from high pressure water jets from any direction

INDEX

	page		page
14. BROCHURE HOLDERS	190		
<i>Porta documenti</i>			
<i>Portafolletos</i>			
<i>Porte-brochures</i>			
14.1 Scritto® Brochure Holders	192	16.1 Indoor Flags	232
<i>Porta documenti Scritto®</i>		<i>Bandiere da interno</i>	
<i>Scritto® Portafolletos</i>		<i>Banderas para Interior</i>	
<i>Scritto® Porte-brochures</i>		<i>Drapeaux intérieur</i>	
14.2 Taymar® Brochure Holders	193	16.2 Outdoor Flags	236
<i>Porta documenti Taymar®</i>		<i>Bandiere da esterno</i>	
<i>Taymar® Portafolletos</i>		<i>Banderas para Exterior</i>	
<i>Taymar® Porte-brochures</i>		<i>Drapeaux d'extérieur</i>	
14.3 Business Card Holders	196	16.3 Accessories	242
<i>Porta biglietti da visita</i>		<i>Accessori</i>	
<i>Portafolletos Tarjetas de Visita</i>		<i>Accesorios</i>	
<i>Porte-cartes de Visite</i>		<i>Accessoires</i>	
14.4 Outdoor Leaflet Holders	197	16. COUNTERS AND TABLE COVERS	244
<i>Porta biglietti da visita per uso esterno</i>		<i>Banchetti e tovaglie</i>	
<i>Portafolletos para Exteriores</i>		<i>Mostradores y Cubiertas de Mesa</i>	
<i>Porte-brochures pour Extérieur</i>		<i>Comptoirs et Housses de Table</i>	
14.5 Name Badges and Brochure Holder	198	17.1 Counters and Accessories	246
<i>Magnetic</i>		<i>Banchetti e accessori</i>	
<i>Portanomi e portadocumenti magnetici</i>		<i>Mostradores y Accesorios</i>	
<i>Porta Nombres y Portafolletos Magnético</i>		<i>Comptoirs et Accessoires</i>	
<i>Badges Nominatifs et Porte-brochures</i>		17.2 Table Covers	258
<i>Magnétique</i>		<i>Tovaglie</i>	
		<i>Cubiertas de Mesa</i>	
		<i>Housses de Table</i>	
15. PORTA BANNERS	202	17. WALLS	260
<i>Porta banners</i>		<i>Pareti</i>	
<i>Banners</i>		<i>Paneles Promocionales</i>	
<i>Banners</i>		<i>Murs</i>	
15.1 Roll-Banners	204	18.1 Lightboxes	262
<i>Roll-Banners</i>		<i>Cassonetti luminosi</i>	
<i>Roll-Banners</i>		<i>Cajas de luz</i>	
<i>Roll-Banners</i>		<i>Caissons lumineux</i>	
15.2 Bannerstands	214	18.2 Pop-Ups	264
<i>Porta banners</i>		<i>Pop-Ups</i>	
<i>Banner</i>		<i>Pop-Ups</i>	
<i>Supports pour Bannières</i>		<i>Stands Parapluie</i>	
15.3 Hanging Banners	226	18.3 Zipper-Walls	270
<i>Porta banners a sospensione</i>		<i>Zipper-Walls</i>	
<i>Banners Colgantes</i>		<i>Otras Paneles</i>	
<i>Banners Suspendues</i>		<i>Autres Murs</i>	
15.4 Accessories	228	18.4 Other Walls	274
<i>Accessori</i>		<i>Altre pareti</i>	
<i>Accesorios</i>		<i>Andere Wände</i>	
<i>Accessoires</i>		<i>Overige Wanden</i>	
		18. TENTS	278
		<i>Tende</i>	
		<i>Carpas</i>	
		<i>Tentes</i>	
19. FLAGS	230	19.1 Tents and Accessories	280
<i>Bandiere</i>		<i>Tende e accessori</i>	
<i>Banderas</i>		<i>Carpas y Accesorios</i>	
<i>Drapeaux</i>		<i>Tentes et Accessoires</i>	



POINT OF SALE

P. 8



HOSPITALITY

P. 106



OFFICE

P. 146



PROMOTIONS AND EVENTS

P. 200

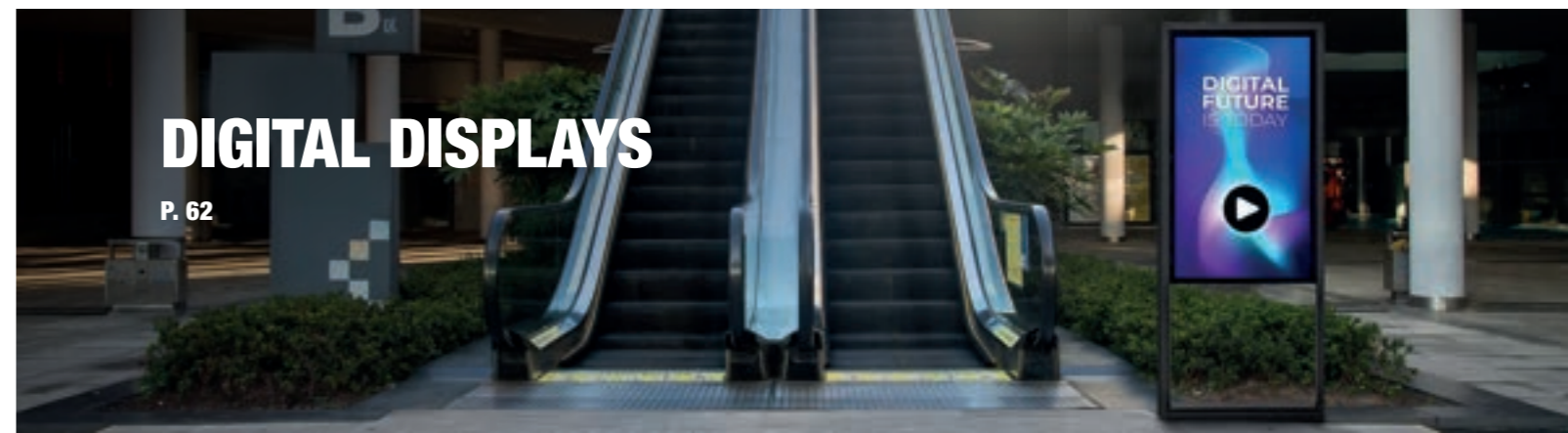

DIGITAL DISPLAYS

P. 62



POSTER DISPLAY DECOR SWAY
See 1. Poster Frames and Displays page 30



POSTER DISPLAY DECOR CLICK
See 1. Poster Frames and Displays page 31



TEXTILE FRAME TOWER
See 2. Textile Frames page 40



A-BOARD ELEGANT STEEL
See 5. Pavement Signs page 90



WOODEN A-BOARD FLIP
See 7. Wooden Signs page 110



WOODEN A-BOARD ECONOMY
See 7. Wooden Signs page 111



WOODEN T STAND MENU HOLDER
See 7. Wooden Signs page 119



DIGITAL A-BOARD SPECTRUM
See 4. Digital Displays page 74



DIGITAL TOTEM SKY
See 4. Digital Displays page 67



SMART LINE DIGITAL TOTEM DOUBLE-SIDED
See 4. Digital Displays page 67



SMART LINE DIGITAL TOTEM RACK
See 4. Digital Displays page 66



BLACK LETTER BOARD
See 7. Wooden Signs page 118

SET OF WHITE PLASTIC LETTERS
See 7. Wooden Signs page 121



INDOOR LOCKABLE SHOWCASE WITH SLIDING DOORS SLIM WITH SAFETY CORNERS
See 10. Lockable Notice Boards page 153



DIGITAL COUNTER FUTURO VERTICAL
See 4. Digital Displays page 76

EXTENDED RANGE



55"



65"



50"



PANEL BASE STEEL
See 15. Banners page 218



BEACH FLAG ALU PADDLE
See 16. Flags page 238



BEACH FLAG FIBER PADDLE
See 16. Flags page 240



COUNTER EASY OVAL
See 17. Counters and Table Covers page 253

POINT OF SALE

Punto di Vendita
Punto de Venta
Point de vente

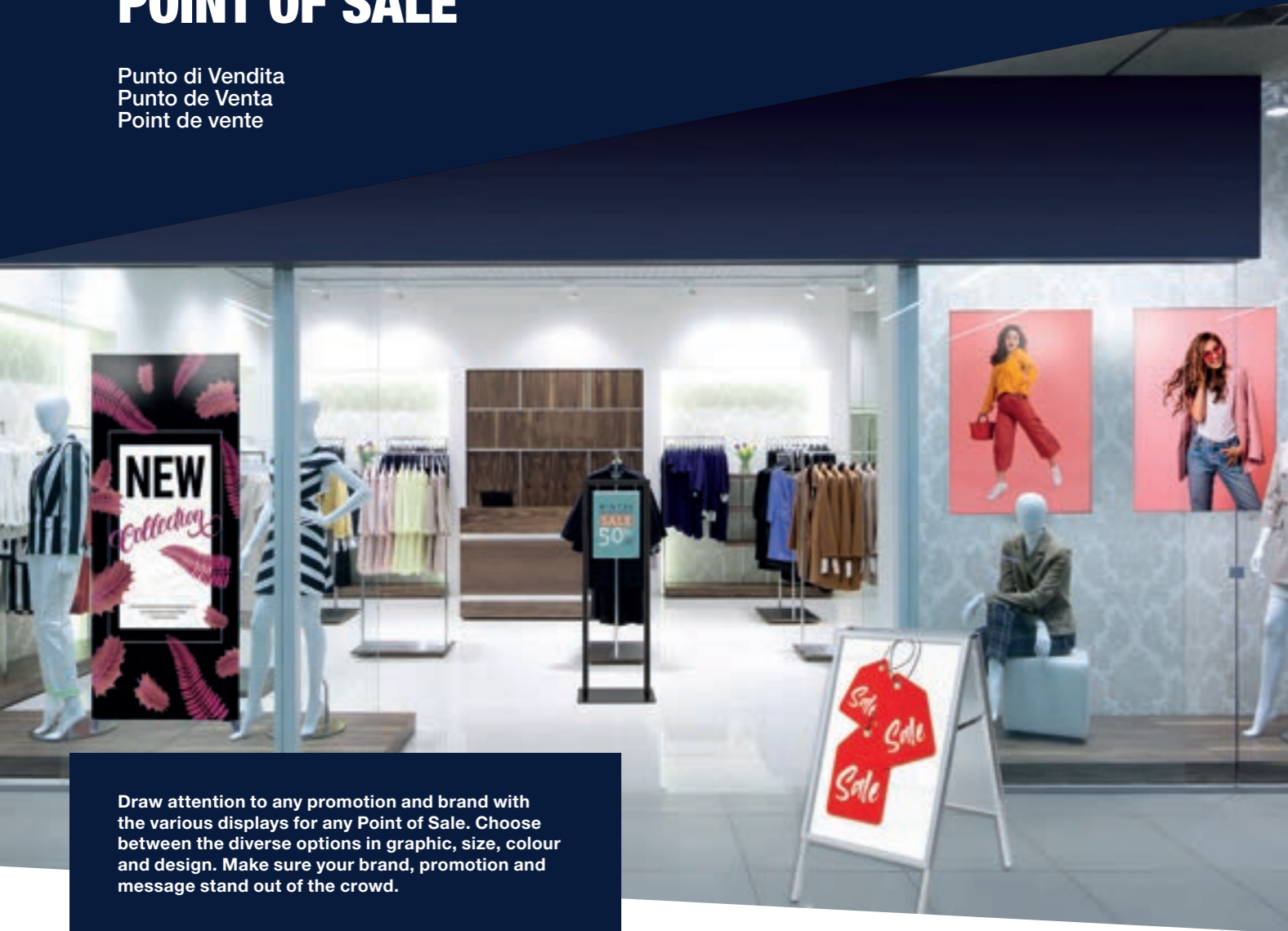

Draw attention to any promotion and brand with the various displays for any Point of Sale. Choose between the diverse options in graphic, size, colour and design. Make sure your brand, promotion and message stand out of the crowd.



TEXTILE FRAME ELEGANT BLACK
See 2. Textile Frames
page 42



TRIGRIP STAND STEEL
See 4. Digital Displays
page 78



DIGITAL A-BOARD SPECTRUM
See 4. Digital Displays
page 74

NEW



A-BOARD ELEGANT STEEL
See 5. Pavement Signs
page 90



LED SLIDE IN FRAME SLIM
See 3. Illuminated Displays
page 50



DIGITAL COUNTER FUTURO
See 4. Digital Displays
page 76

NEW



WINDTALKER® CITY WITH PLASTIC BASE
See 5. Pavement Signs
page 93



POSTER DISPLAY DECOR CLICK
See 1. Poster Frames and Displays
page 31

NEW



POSTER DISPLAY DECOR SWAY
See 1. Poster Frames and Displays
page 30

NEW

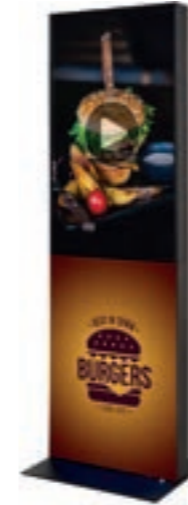

DIGITAL FABRIC TOTEM
See 4. Digital Displays
page 72



SMART LINE DIGITAL A-BOARD
See 4. Digital Displays
page 75



SMART LINE DIGITAL PANEL
See 4. Digital Displays
page 73



POSTER DISPLAY SWING
See 1. Poster Frames and Displays
page 29

interesting categories for you

1. POSTER FRAMES AND DISPLAYS	10
2. TEXTILE FRAMES	36
3. ILLUMINATED DISPLAYS	48
4. DIGITAL DISPLAYS	62
5. PAVEMENT SIGNS	82
6. LEAFLET AND CATALOGUE HOLDERS	96
8. MENU DISPLAYS	122
10. LOCKABLE NOTICE BOARDS	148
12. WAYFINDING SYSTEMS	176
15. BANNERS	202
16. FLAGS	230

1. POSTER FRAMES AND DISPLAYS

Porta poster e Espositori
Marcos para Póster y Expositores
Cadres et présentoirs d'affiches

A perfect display to present posters, photographs or showcase art. Thanks to the diverse range of products you always find the solution. Ensure an effortless exchange of graphics in just a few seconds. From simple to more decorative designs, the Poster Frames and Displays ensure an elegant look. Available in different sizes and colours.

- WIDE RANGE OF PRODUCTS, PROFILE WIDTHS AND DESIGNS
- QUICK AND EASY CHANGE OF POSTER
- POSSIBLE TO BRAND WITH SILK SCREEN PRINT LOGO

INDEX

1.1 Snap Frames <i>Cornici a scatto</i> <i>Marco para Póster</i> <i>Cadres Clic Clac</i>	14
1.2 Poster Frames <i>Porta poster</i> <i>Marco para Póster</i> <i>Cadres Poster</i>	22
1.3 Poster Displays <i>Espositori</i> <i>Porta Póster</i> <i>Panneaux d’Affichage</i>	26
1.4 Appendo Cable Systems <i>Porta poster con cavetti</i> <i>Appendo</i> <i>Sistemas de Cable</i> <i>Appendo</i> <i>Systèmes de Câblage</i> <i>Appendo</i>	34



GOOD



25 MM SNAP FRAME STANDARD

- Bestseller profile width 25 mm
- Perfect solution for poster sizes A5 up to A0
- Mitred or rounded corners



BETTER



37 MM SNAP FRAME COMPASSO®

- Unique aluminium frame design
- Premium double frame look
- Anti-glare foil for optimal poster protection



BEST



LOCKABLE POSTER CASE ECONOMY

- Lockable poster case with enhanced security
- Impact resistant
- Profile 37 mm

SNAP FRAMES

- Anti-glare front cover with snap shut profiles
- For wall fix applications (ceiling suspension hooks provided on request)
- Screws and wall plugs are included
- Supplied individually boxed

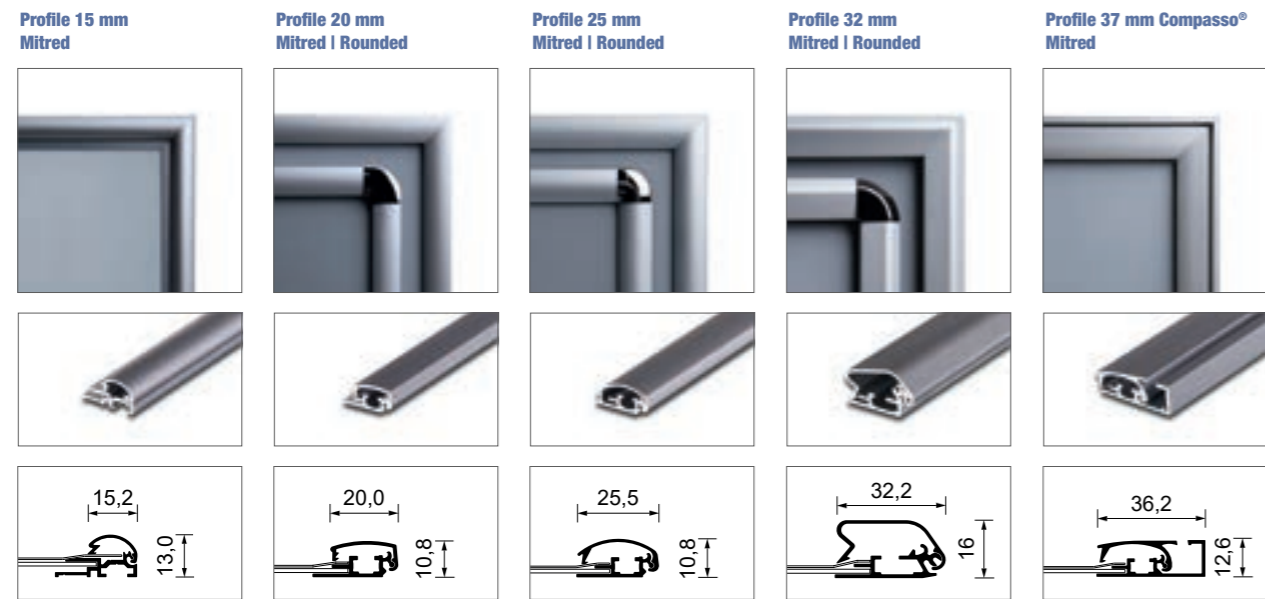

Quick and easy poster change without removing from the wall
Snap open the sides, place your poster behind the anti-glare sheet and snap shut.

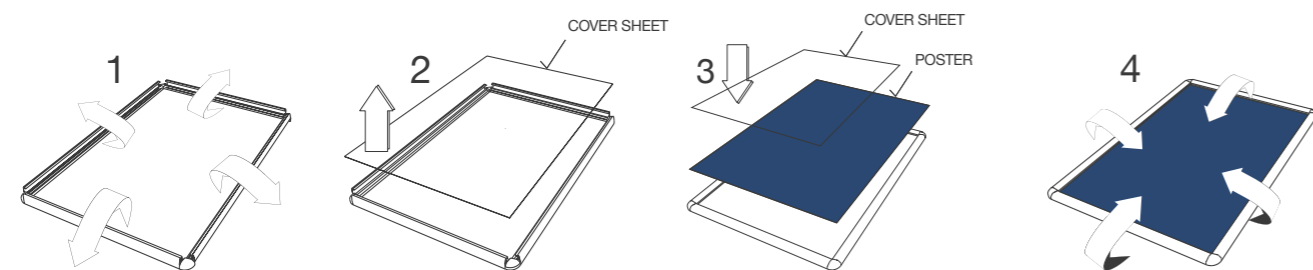

1.1 SNAP FRAMES

37 MM SNAP FRAME COMPASSO®

- IT**
- Cornice in alluminio con un design unico
 - Effetto doppia cornice Premium
 - Copertura antiriflesso per una protezione ottimale delle locandine
- ES**
- Diseño exclusivo de marco de aluminio
 - Estética de doble perfil Premium
 - Folio protector antirreflejante para la óptima protección de la gráfica
- FR**
- Cadre unique en aluminium
 - Cadre double de qualité
 - Film anti-reflet pour une protection optimale des posters

Art. nr.	DIN/Size	Dimensions (cm)			
		W	H	D	KG
KRA4G37	A4	26,4	35,1	1,3	0,7
KRA3G37	A3	35,1	47,4	1,3	1
KRA2G37	A2	47,4	64,8	1,3	1,5
KRA1G37	A1	64,8	89,5	1,3	2,3
KRA0G37	A0	89,5	124,3	1,3	3,6
KR50x70G37	50 x 70	55,4	75,4	1,3	1,8
KR70x100G37	70 x 100	75,4	105,4	1,3	2,9

Including splashproof Poster Bag

KRA4G37WR	A4	26,4	35,1	1,3	0,8
KRA3G37WR	A3	35,1	47,4	1,3	1,1
KRA2G37WR	A2	47,4	64,8	1,3	1,6
KRA1G37WR	A1	64,8	89,5	1,3	2,8
KRA0G37WR	A0	89,5	124,3	1,3	4,7
KR50x70G37WR	50 x 70	55,4	75,4	1,3	2
KR70x100G37WR	70 x 100	75,4	105,4	1,3	2,9

- Colour combinations available on request
- All codes that include WR are for outdoor use (IP53)

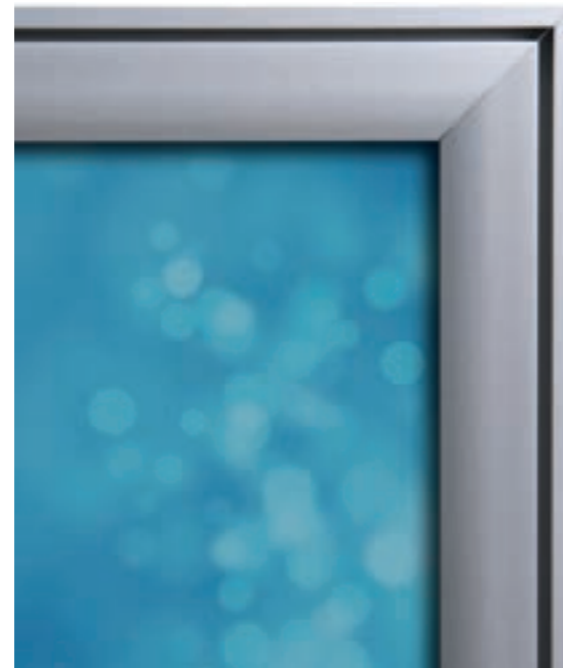

20 MM SNAP FRAME SLIM

- IT**
- Aspetto sottile grazie alla curva di profilo superficiale
 - Bordi squadretti o arrotondati
 - Soluzione perfetta per locandine nei formati da A5 ad A1
- ES**
- Aspecto sutil debido a la curva de perfil superficial
 - Esquinas en forma redondeada o inglete
 - Solución perfecta para gráficas más pequeñas desde DIN A5 hasta A1
- FR**
- Aspect délicat grace à la courbe de profil faible
 - Coins biseautés ou arrondis
 - Solution idéale pour les petits posters de format A5 à 700 x 1000 mm

Art. nr.	DIN/Size	Dimensions (cm)			
		W	H	D	KG
Mitred corner					
KRA5G20	A5	17,7	23,9	1,1	0,3
KRA4G20	A4	23,9	32,6	1,1	0,6
KRA3G20	A3	32,6	44,9	1,1	0,9
KRA2G20	A2	44,9	62,3	1,1	1,4
KRA1G20	A1	62,3	87	1,1	2,3

Rounded corner					
KRA5R20	A5	17,7	23,9	1,1	0,3
KRA4R20	A4	23,9	32,6	1,1	0,6
KRA3R20	A3	32,6	44,9	1,1	0,9
KRA2R20	A2	44,9	62,3	1,1	1,4
KRA1R20	A1	62,3	87	1,1	2,3

- Splashproof Poster Bag, Hanging Hooks and Support optional for all Snap Frames (see p. 21)

20 mm Snap Frame Slim (p. 15/ch. 1) and Barrier Flexi Belt Post (p. 180/ch. 12)



15 MM SNAP FRAME

- IT**
- Perfetta per locandine nei formati da A5 ad A1
 - Sostituzione rapida locandine
 - Bordi squadretti
- ES**
- Perfecto para gráficas desde DIN A5 hasta DIN A1
 - Cambio rápido de la gráfica
 - Esquinas en inglete
- FR**
- Idéal pour les posters de format A5 à A1
 - Remplacement rapide du poster
 - Coins biseautés

Art. nr.	DIN/Size	Dimensions (cm)			
		W	H	D	KG
KRA5G15	A5	16	22,2	1,3	0,3
KRA4G15	A4	22,2	30,9	1,3	0,5
KRA3G15	A3	30,9	43,2	1,3	0,7
KRA2G15	A2	43,2	60,6	1,3	1,1
KRA1G15	A1	60,6	85,3	1,3	1,8

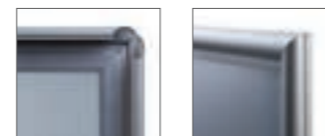

25 MM SNAP FRAME STANDARD

BESTSELLER

- IT**
 - Profilo bestseller con un'ampiezza di 25 mm
 - Soluzione perfetta per locandine nei formati da A5 fino ad A0
 - Bordi squadrati o arrotondati
- ES**
 - Perfil de 25 mm de ancho, el más vendido
 - Solución perfecta para gráficas de tamaño desde DIN A5 hasta DIN A0
 - Esquinas en inglete o redondeadas
- FR**
 - Profil best-seller de 25 mm de large
 - Solution parfaite pour les posters de tailles A5 à A0
 - Coins biseautés ou arrondis



Art. nr.	DIN/Size	Dimensions (cm)			
		W	H	D	KG
Mitred corner					
KRA5G25	A5	17,9	24,1	1,1	0,3
KRA4G25	A4	24,1	32,8	1,1	0,5
KRA3G25	A3	32,8	45,1	1,1	0,7
KRA2G25	A2	45,1	62,5	1,1	1
KRA1G25	A1	62,5	87,2	1,1	1,7
KRA0G25	A0	87,2	122	1,1	2,8
KR50x70G25	50 x 70	53,1	73,1	1,1	1,3
KR70x100G25	70 x 100	73,1	103,1	1,1	2,2

Rounded corner					
Art. nr.	DIN/Size	W	H	D	KG
KRA4R25	A4	24,1	32,8	1,1	0,4
KRA3R25	A3	32,8	45,1	1,1	0,6
KRA2R25	A2	45,1	62,5	1,1	1
KRA1R25	A1	62,5	87,2	1,1	1,6
KRA0R25	A0	87,2	122	1,1	2,8
KR50x70R25	50 x 70	53,1	73,1	1,1	1,3
KR70x100R25	70 x 100	73,1	103,1	1,1	2,2



Security Snap Frame is available on request

25 MM SNAP FRAME GOLD

- IT**
 - Effetto esclusivo
 - Profilo di design curvo
 - Perfetta per locandine nei formati da A4 ad A0
- ES**
 - Aspecto exclusivo
 - Perfil de diseño curvado
 - Perfecto para gráficas desde DIN A4 hasta DIN A0
- FR**
 - Look exclusif
 - Profil incurvé
 - Parfait pour les tailles de poster A4 à A0



Art. nr.	DIN/Size	Dimensions (cm)			
		W	H	D	KG
KRA4G25GOLD	A4	24,1	32,8	1,1	0,6
KRA3G25GOLD	A3	32,8	45,1	1,1	0,9
KRA2G25GOLD	A2	45,1	62,5	1,1	1,4
KRA1G25GOLD	A1	62,5	87,2	1,1	2,3

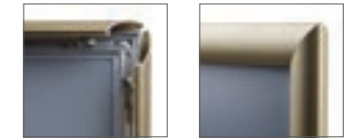

Splashproof Poster Bag, Hanging Hooks and Support optional for all Snap Frames (see p. 21)

25 mm RAL Colour Snap Frame (p. 18/ch. 1)

FIRE RATED 25 MM SNAP FRAME

- IT**
 - Certificazione classe antincendio B1
 - Fondo in metallo resistente agli urti
 - Perfetta per le scuole e gli edifici pubblici
- ES**
 - Protección ignífuga con certificación B1
 - Trasera metálica resistente al impacto
 - Perfecto para colegios y administraciones públicas
- FR**
 - Protection incendie certification B1
 - Panneau arrière en métal résistant aux chocs
 - Idéal pour les écoles et les bâtiments publics



Art. nr.	DIN/Size	Dimensions (cm)			
		W	H	D	KG
KRA4G25B1	A4	24,1	32,8	1,1	0,9
KRA3G25B1	A3	32,8	45,1	1,1	1,5
KRA2G25B1	A2	45,1	62,5	1,1	2,6
KRA1G25B1	A1	62,5	87,2	1,1	4,5
KRA0G25B1	A0	87,2	122	1,1	8,3
KR50x70G25B1	50 x 70	53,1	73,1	1,1	3,3
KR70x100G25B1	70 x 100	73,1	103,1	1,1	6



Frame Hanging Kit and Hanging Hooks for Snap Frames used together due to metal backwall (see p. 21)



25 MM RAL COLOUR SNAP FRAME

- IT**
- Perfetta per i formati da A4 ad A0
 - Verniciatura a polvere semilucida RAL
 - Bordi squadrati
- ES**
- Perfecto desde DIN A4 hasta DIN A0
 - Acabado del RAL semi-brillante
 - Esquinas en inglete
- FR**
- Parfait pour les formats A4 à A0
 - Finition semi-brillante par revêtement en poudre RAL
 - Coins biseautés

Art. nr.	☒	DIN/Size	Dimensions (cm)			
			W	H	D	KG
KRA4G25C9005	●	A4	24,1	32,8	1,1	0,6
KRA3G25C9005	●	A3	32,8	45,1	1,1	0,9
KRA2G25C9005	●	A2	45,1	62,5	1,1	1,4
KRA1G25C9005	●	A1	62,5	87,2	1,1	2,3
KRA0G25C9005	●	A0	87,2	122	1,1	4,1
KR50x70G25C9005	●	50 x 70	53,1	73,1	1,1	1,8
KR70x100G25C9005	●	70 x 100	73,1	103,1	1,1	3,1
KRA4G25C9003	○	A4	24,1	32,8	1,1	0,6
KRA3G25C9003	○	A3	32,8	45,1	1,1	0,9
KRA2G25C9003	○	A2	45,1	62,5	1,1	1,4
KRA1G25C9003	○	A1	62,5	87,2	1,1	2,3
KRA0G25C9003	○	A0	87,2	122	1,1	4,1
KR50x70G25C9003	○	50 x 70	53,1	73,1	1,1	1,8
KR70x100G25C9003	○	70 x 100	73,1	103,1	1,1	3,1
KRA4G25C3020	●	A4	24,1	32,8	1,1	0,6
KRA3G25C3020	●	A3	32,8	45,1	1,1	0,9
KRA2G25C3020	●	A2	45,1	62,5	1,1	1,4
KRA1G25C3020	●	A1	62,5	87,2	1,1	2,3
KRA0G25C3020	●	A0	87,2	122	1,1	4,1
KRA4G25C5010	●	A4	24,1	32,8	1,1	0,6
KRA3G25C5010	●	A3	32,8	45,1	1,1	0,9



WINDOW SNAP FRAME

- IT**
- Ideale per le vetrine dei negozi
 - Cornice biadesiva
 - Rimovibile senza lasciare tracce
- ES**
- Ideal para escaparates
 - Marco de doble cara adhesivo
 - Removible sin dejar rastro
- FR**
- Idéal pour une utilisation en atelier
 - Cadre adhésif double face
 - Amovible sans traces

Art. nr.	DIN/Size	Dimensions (cm)			
Profile 25 mm					
WKRA3G25	A3	32,8	45,1	1,1	1
WKRA2G25	A2	45,1	62,5	1,1	1,6
WKRA1G25	A1	62,5	87,2	1,1	2,6
WKRA0G25	A0	87,2	122	1,1	4,5
WKR70x100G25	70 x 100	73,1	103,1	1,1	3,3
Profile 32 mm					
WKR70x100G32	70 x 100	74,5	104,5	1,6	3,5



☒ Adhesive tape fixed Snap Frame and additional cover profiles for outside of the window

32 MM SNAP FRAME

- IT**
- Perfetta per locandine di grandi formati
 - Classico profilo solido da 32 mm
 - Fondo altamente resistente agli urti
- ES**
- Perfecto para gráficas de gran tamaño
 - Perfil robusto y clásico de 32 mm
 - Trasera de alta resistencia a impactos
- FR**
- Parfait pour les grands posters
 - Profilé solide et classique de 32 mm
 - Paroi arrière résistante aux chocs

Art. nr.	DIN/Size	Dimensions (cm)			
Mitred corner					
KRA3G32	A3	34,2	46,5	1,6	1,2
KRA2G32	A2	46,5	63,9	1,6	1,6
KRA1G32	A1	63,9	88,6	1,6	2,9
KRA0G32	A0	88,6	123,4	1,6	5,2
KR50x70G32	50 x 70	54,5	74,5	1,6	2,2
KR70x100G32	70 x 100	74,5	104,5	1,6	3,1
KR100x140G32	100 x 140	104,5	144,5	1,6	6,6
Rounded corner					
KRA3R32	A3	34,2	46,5	1,6	1,1
KRA2R32	A2	46,5	63,9	1,6	1,6
KRA1R32	A1	63,9	88,6	1,6	2,8
KRA0R32	A0	88,6	123,4	1,6	5,1
KR50x70R32	50 x 70	54,5	74,5	1,6	2,2
KR70x100R32	70 x 100	74,5	104,5	1,6	3,1
KR100x140R32	100 x 140	104,5	144,5	1,6	6,6



☒ Security Snap Frame is available on request

SCRITTO® SNAP FRAME

- IT**
- Pellicola protettiva antiriflesso resistente ai raggi UV
 - Posizione orizzontale o verticale
 - Fondo in plastica rigida
- ES**
- Folio protector antirreflejos y contra rayos ultravioleta
 - Posición vertical u horizontal
 - Pared trasera de plástico duro
- FR**
- Film de protection antireflet résistant aux UV
 - Position portrait ou paysage
 - Paroi arrière en plastique dur

Art. nr.	DIN/Size	Dimensions (cm)			
KRA4G25ABS	A4	24,1	32,8	1,1	0,31



☒ Optimal for industrial places
☒ Profile of 25 mm

FIRE RATED 32 MM SNAP FRAME

- IT**
- DIN4102 classe antincendio B1
 - Cornice nella versione con la massima durata
 - Ideale per scuole eD edifici pubblici
- ES**
- Protección ignífuga B1 (DIN4102)
 - Versión de marco de más durabilidad
 - Ideal para colegios y administraciones públicas
- FR**
- Protection B1 contre les incendies DIN4102
 - Version cadre avec la plus grande durabilité
 - Idéal pour les écoles et les bâtiments publics



Art. nr.	DIN/Size	Dimensions (cm)			
		W	H	D	KG
KRA3G32B1	A3	34,2	46,5	1,6	1,8
KRA2G32B1	A2	46,5	63,9	1,6	3
KRA1G32B1	A1	63,9	88,6	1,6	5,1
KRA0G32B1	A0	88,6	123,4	1,6	9
KR50x70G32B1	50 x 70	54,5	74,5	1,6	3,7
KR70x100G32B1	70 x 100	74,5	104,5	1,6	6,5

For suspension use Frame Hanging Kit and Hanging Hooks for Snap Frames together, due to metal back wall (see p. 21)

37 mm Snap Frame Compasso® (p. 14/ch. 1)

SPLASHPROOF POSTER BAG

Accessory for all Snap Frames and A-Boards

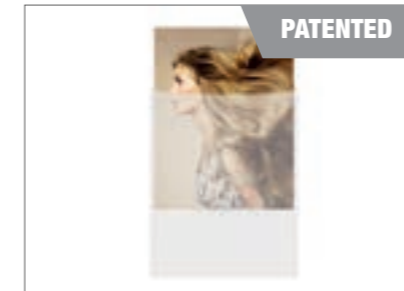

- IT**
- Durata della locandina maggiore - busta in PVC resistente ai raggi UV
- ES**
- Vida útil prolongada del póster: bolsa de PVC resistente a los rayos UV
- FR**
- Prolongation de la durée de vie des affiches - enveloppe en PVC résistant aux UV

IP53 splashproof

- Art. nr.
- WRBAGA4
 - WRBAGA3
 - WRBAGA2
 - WRBAGA1
 - WRBAG50x70
 - WRBAG70x100

HANGING HOOKS FOR SNAP FRAMES (2 PCS)

Accessory for all Snap Frames



- IT**
- Installazione della Cornice a Scatto semplice e veloce
- ES**
- Instalación de marco rápida y sencilla
- FR**
- Installation simple et rapide du cadre clic-clac d'affichage

Art. nr. HHKR

FRAME HANGING KIT

Accessory for Fire Rated 25 mm Snap Frame, Fire Rated 32 mm Snap Frame and Postersnapper



- IT**
- Kit di montaggio per sospensione da soffitto
- ES**
- Set de suspensión para suspensión de techo
- FR**
- Ensemble de suspension pour suspension au plafond

Art. nr. HSKR

POSTER FOIL, FOIL SET

Accessory for Snap Frames, A-Boards and Windtalker®



- IT**
- Copertura locandina stabile ai raggi UV antiriflesso
- ES**
- Folio protector antirreflejos y anti-UV
- FR**
- Protection antireflet résistante aux UV pour les posters

- Art. nr.
- | Foil | Foil Set (2 pcs) |
|-------------|------------------|
| FOILA4* | SETFZPA4 |
| FOILA3* | SETFZPA3 |
| FOILA2* | SETFZPA2 |
| FOILA1* | SETFZPA1 |
| FOILA0* | SETFZPA0 |
| FOIL50x70* | SETFZP50x70 |
| FOIL70x100* | SETFZP70x100 |



POSTERSNAPPER

BESTSELLER

- IT**
 - Presentazione locandina rapida ed economica
 - Guida da 25 mm su due lati, superiore e inferiore
 - Trasporto e montaggio semplici
- ES**
 - Presentación de gráfica rápida y económica
 - Riel de sujeción de 25 mm superior e inferior
 - Fácil de transportar y montar
- FR**
 - Présentation rapide et bon marché du poster
 - Rail à pression de 25 mm en haut et en bas
 - Transport et montage faciles



Art. nr.	DIN/Size	Dimensions (cm)			
		W	H	D	KG
PP30	29,7 x 30,2	30,5	45	1,2	0,2
PP42	42 x 42,5	42,5	62,4	1,2	0,3
PP50	50 x 50,5	50,5	73	1,2	0,3
PP60	59,4 x 59,9	60	87,1	1,2	0,4
PP70	70 x 70,5	70,5	103	1,2	0,4
PP85	84,1 x 84,6	84,5	121,9	1,2	0,5
PP100	100 x 100,5	100,5	143	1,2	0,6
PP120	120 x 120,5	120,5	123	1,2	0,7
PP150	150 x 150,5	150,5	153	1,2	0,9
PP300	300 x 300,5	300,5	203	1,2	1,7

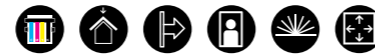
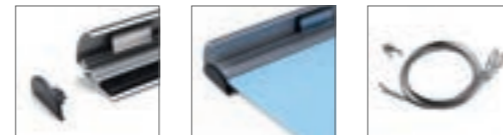

Optional: Frame Hanging Kit (see p. 21)

POSTERSTRETCH® DISPLAY

- IT**
 - Struttura leggera in alluminio anodizzato
 - Le pinze a coccodrillo mantengono la locandina in perfetta posizione
 - Profilo tubolare ovale con chiusura a scatto negli angoli color argento
- ES**
 - Construcción en aluminio anodizado ligero
 - Pinzas de sujeción para mantener su gráfica en perfecta posición
 - Perfil tubular introducido en esquinas de color gris plata
- FR**
 - Structure en aluminium à motif anodisé clair
 - Les pinces crocodile maintiennent parfaitement le poster
 - Profil de tube ovale avec coins gris argenté à enfoncer

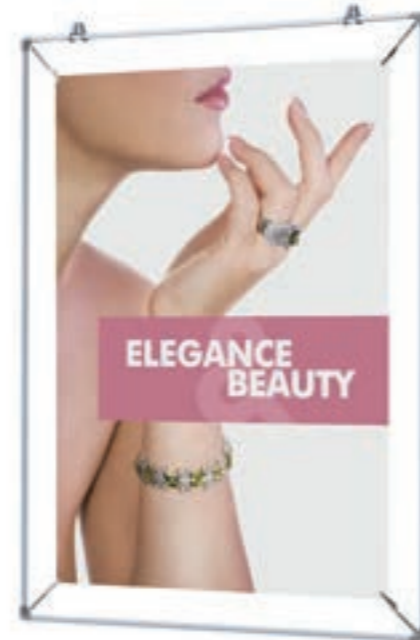

Art. nr.	DIN/Size	Dimensions (cm)			
		W	H	D	KG
PSOA2	A2	52,6	70	1,2	0,2
PSOA1	A1	70	94,7	1,2	0,3
PSOA0	A0	94,7	129,5	1,2	0,4
PSO70x100	70 x 100	80,6	110,6	1,2	0,3



Frame Hanging Kit Suction Cups
SUCTIONCUPS

INFOTOPPER

- IT**
 - Autoportante con fissaggio con nastro adesivo
 - Resistente alle intemperie (antispruzzo)
 - Ideale per l'esposizione di locandine all'esterno
- ES**
 - Independiente
 - Resistente a la intemperie (a prueba de salpicaduras)
 - Ideal para presentación en exteriores
- FR**
 - Sur pied
 - Résistant aux intempéries (éclaboussures)
 - Idéal pour la présentation de posters en extérieur



Art. nr.	DIN/Size	Dimensions (cm)			
		W	H	D	KG
ITA4	A4	32,8	23,6	4,4	0,9
ITA3	A3	45,1	32,3	4,4	1,3

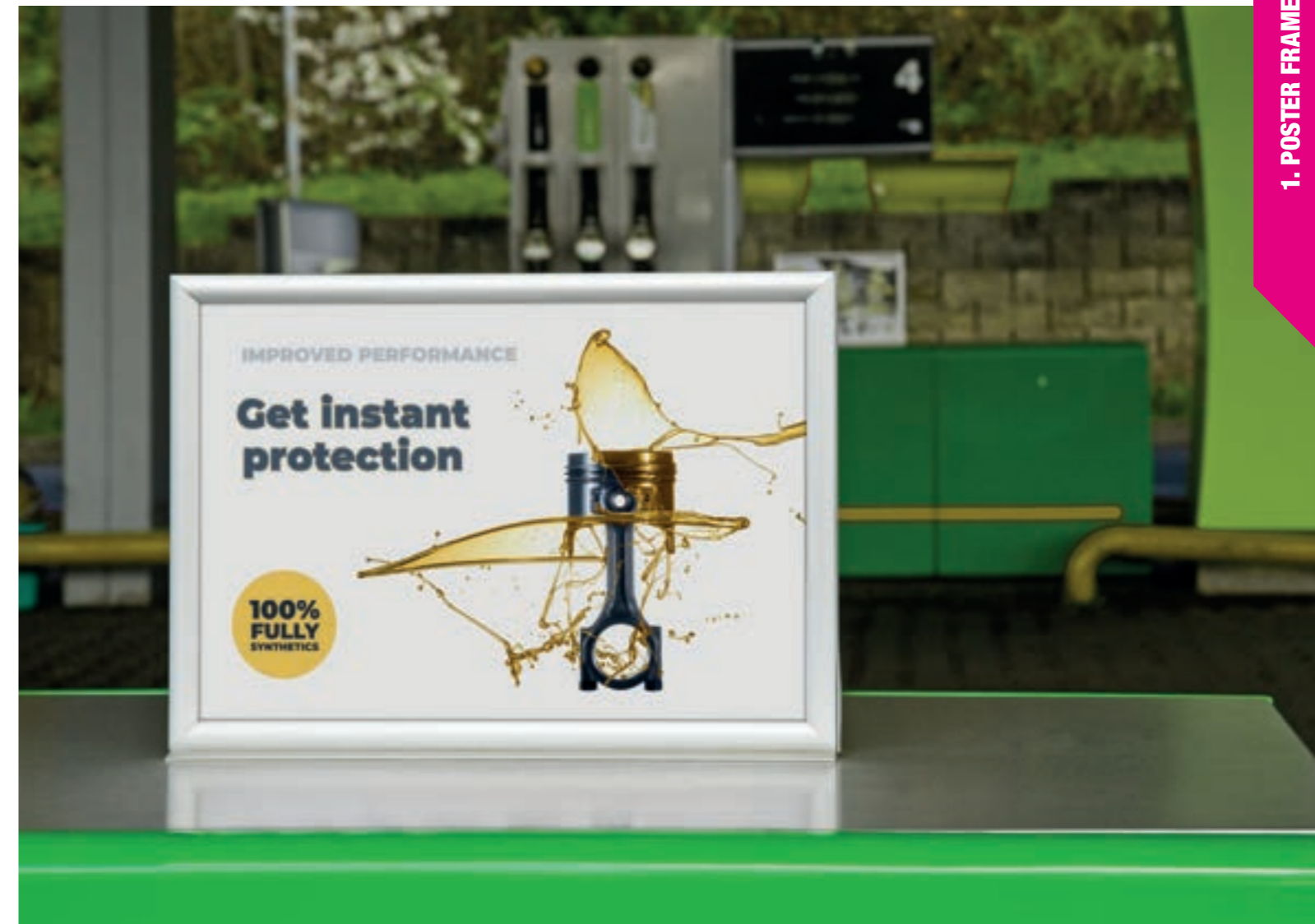

LOCKABLE POSTER CASE ECONOMY

BESTSELLER

- IT**
 - Bacheca con serratura che offre una maggiore sicurezza
 - Resistente agli urti
 - Profilo da 37 mm con fondo in plastica
- ES**
 - Un Portaposter con el cierre de seguridad mejorado
 - Resistente al impacto
 - Perfil de 37 mm con pared posterior de plástico
- FR**
 - Boîtier pour poster verrouillable avec sécurité renforcée
 - Résistant aux chocs
 - Profilé de 37 mm avec paroi arrière en plastique



Art. nr.	DIN/Size	Dimensions (cm)			
		W	H	D	KG
SCPA4	A4	26,6	35,3	2,3	1,5
SCPA3	A3	35,3	47,6	2,3	2
SCPA2	A2	47,6	65	2,3	2,8
SCPA1	A1	65	89,7	2,3	4,2
SCPA0	A0	89,7	124,5	2,3	6,6
SCP50x70	50 x 70	55,6	75,6	2,3	3,4
SCP70x100	70 x 100	75,6	105,6	2,3	5,2



LOCKABLE POSTER CASE WITH GALVANISED BACKWALL

BESTSELLER

- IT**
 - Cornice pubblicitaria con maggiore sicurezza
 - Resistente agli urti
 - Profilo da 53 mm
- ES**
 - Seguridad de marco para gráfica aumentada
 - Resistente al impacto
 - Perfil de 53 mm
- FR**
 - Cadre de sécurité améliorée pour poster
 - Résistant aux chocs
 - Profil 53 mm



Art. nr.	DIN/Size	Dimensions (cm)			
		W	H	D	KG
SCPXA4	A4	30	38,7	3,3	2,8
SCPXA3	A3	38,7	51	3,3	3,5
SCPXA2	A2	51	68,4	3,3	4,7
SCPXA1	A1	68,4	93,1	3,3	5,9
SCPXA0	A0	93,1	127,9	3,3	10,6
SCPX50x70	50 x 70	59	79	3,3	5,6
SCPX70x100	70 x 100	79	109	3,3	8,4

MAGNETIC POSTER FRAME SLIM

- IT**
 - Design sofisticato e snello
 - Facile sostituzione del poster grazie alla ventosa
 - Pannello resistente ai raggi UV e antiriflesso
- ES**
 - Diseño sofisticado y estilizado
 - Fácil de cambiar el poster gracias a la ventosa
 - Panel frontal sin reflejos y resistente a los rayos UV
- FR**
 - Conception sophistiquée et fine
 - Changement facile de l'affiche grâce à la ventouse
 - Face avant résistante aux UV et anti-éblouissement



Art. nr.	DIN/Size	Dimensions (cm)			
		W	H	D	KG
PEFA4C9005	A4	23,5	32,2	6	0,7
PEFA3C9005	A3	32,2	44,5	6	1,2
PEFA2C9005	A2	44,5	61,7	6	2,2
PEFA1C9005	A1	61,7	86,5	6	4,1



CATCHING POLE DESIGN STANDARD

- IT**
 - 25 mm Cornice a scatto (monofacciale o bifacciale)
 - Uso flessibile in aree interne ed esterne coperte
 - Cornice a scatto con angoli vivi o arrotondati
- ES**
 - Marco abatible de 25 mm (una cara o dos caras)
 - Uso flexible para interior y exterior cubierto
 - Marco abatible con con esquinas redondeadas o unidas en inglete
- FR**
 - Cadre clic-clac de 25 mm (simple ou double face)
 - Utilisation flexible pour les zones intérieures et extérieures couvertes
 - Cadre clic-clac avec coins biseautés ou ronds



Art. nr.	Corner shape	DIN/Size	Dimensions (cm)			
			W	H	D	KG
Single-sided						
CAPOA4G25	Mitred	A4	33	140,4	33	4,9
CAPOA3G25	Mitred	A3	33	146,5	33	5,5
CAPOA4R25	Rounded	A4	33	140,4	33	4,9
CAPOA3R25	Rounded	A3	33	146,5	33	5,5
Double-sided						
CAPOA4G25D	Mitred	A4	33	140,4	33	5,2
CAPOA3G25D	Mitred	A3	33	146,5	33	6
CAPOA4R25D	Rounded	A4	33	140,4	33	5,2
CAPOA3R25D	Rounded	A3	33	146,5	33	6

POSTER FRAME STAND

- IT**
 - Ideale per locandine di grandi formati
 - Design elegante bifacciale con Cornice a Scatto da 25 mm
 - Base pesante in metallo verniciata a polvere per una stabilità estrema
- ES**
 - Idóneo para gráficas en formatos grandes
 - Estructura elegante con marco abatible de 25 mm
 - Base metálica sólida con revestimiento en polvo para mayor estabilidad
- FR**
 - Idéal pour les posters grands formats
 - Structure élégante avec cadre clic-clac de 25 mm
 - Lourde base métallique thermolaquée pour une stabilité extrême

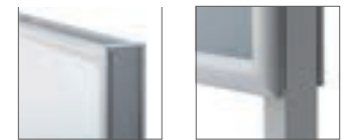

Art. nr.	DIN/Size	Dimensions (cm)			
		W	H	D	KG
PFSA1D	A1	63,1	130,5	33	15,1
PFS70x100D	70 x 100	73,7	130,5	33	17,9

Brochure Holder Design Standard (p. 98/ch. 6), Trys Rotating - Brochure Stand (p. 99/ch. 6) and Poster Frame Stand (p. 27/ch. 1)

INFO BOARD DESIGN STANDARD

- IT**
 - Cornice pubblicitaria monofacciale o bifacciale
 - Estremamente stabile
 - Possibilità di aggiungere ripiano per brochure
- ES**
 - Marco para pósteres de una y dos caras
 - Extremadamente estable
 - Opción de añadir estantería
- FR**
 - Cadre pour affiche simple et double face
 - Extrêmement stable
 - Possibilité d'ajouter une étagère pour brochures



Art. nr.	DIN/Size	Dimensions (cm)			
		W	H	D	KG
Single-sided					
IBA1G25	A1	71,5	185	50	12,2
IB70x100G25	70 x 100	82	185	50	13,1
Double-sided					
IBA1G25D	A1	71,5	185	50	13,9
IB70x100G25D	70 x 100	82	185	50	15,3
Shelf					
P3	3 x A4	64	31	4	3,6

Optional: Shelf P3 (see p. 33)



INFO POLE DESIGN STANDARD

- IT**
- Base stabile e robusta in metallo
 - Cornice a scatto in alluminio da 25 mm con angolo vivo
 - Facile sostituzione del poster
- ES**
- Base metálica estable
 - Marco abatible de aluminio de 25 mm con esquinas unidas en inglete
 - Reemplazo de póster fácil
- FR**
- Base métallique stable
 - Cadre clic-clac en aluminium de 25 mm avec coins biseautés
 - Changement facile du poster

Art. nr.	Corner shape	DIN/Size	Dimensions (cm)			
			W	H	D	KG
Single-sided						
IPM2A1G25	Mitred	A1	62,5	181,5	42,5	15,9
Double-sided						
IPM2A1G25D			62,5	181,5	42,5	17,5
Shelf						
P3I			64	31	4	3,6

- Optional: Shelf P3I (see p. 33)
- Graphic available

Poster Display Swing (p. 29/ch. 1), Textile Frame Elegant Black (p. 42/ch. 2)



POSTER DISPLAY SWING

- IT**
- Design sottile classico e leggero
 - Alternativa conveniente all'Espositore Pubblicitario
 - Facile scambio di locandine con tasca in vetro acrilico bifacciale
- ES**
- Diseño clásico, ligero y fino.
 - Una alternativa económica a los Portaposters
 - Cambio de poster fácil gracias a la carpeta acrílica de doble cara
- FR**
- Design fin, classique et léger
 - Alternative rentable pour l'affichage de posters
 - Échange facile des posters grâce à une pochette acrylique double-face

Art. nr.	DIN/Size	Dimensions (cm)			
		W	H	D	KG
SWSDA4	A4	34	115	28	3,7

- Perfect solution in retail, hospitality and public spaces



• Graphic available

NEW



POSTER DISPLAY DECOR SWAY

- IT**
- Struttura interamente in alluminio
 - Elegante tasca in acrilico
 - Espositore bifacciale per poster
- ES**
- Construcción completamente de aluminio
 - Elegante carpeta acrílica
 - Promoción a doble cara
- FR**
- Conception entièrement en aluminium
 - Pochette élégante en verre acrylique
 - Promotion par affiche recto verso



Art. nr.	DIN/Size	Dimensions (cm)			
		W	H	D	KG
PDSWA2C9005	● A2	56	180,7	45	4,5
PDSWA1C9005	● A1	73,4	180,7	45	5,6
PDSWA2	○ A2	56	180,7	45	4,5
PDSWA1	○ A1	73,4	180,7	45	5,6



POSTER DISPLAY DECOR CLICK

NEW

- IT**
- Formato esclusivamente bifacciale
 - Struttura interamente in alluminio
 - Colore nero o argento
- ES**
- Formato exclusivo de doble cara
 - Construcción de aluminio
 - Color negro o plateado
- FR**
- Format exclusivement recto verso
 - Conception entièrement en aluminium
 - Couleur noire ou argentée



	DIN/Size	Dimensions (cm)			
		W	H	D	KG
PDCLA1DC9005	● A1	63	179,2	53,6	5,9
PDCL2xA1DC9005	● 2 x A1	63	179,2	53,6	8,8
PDCLA1D	○ A1	63	179,2	53,6	5,9
PDCL2xA1D	○ 2 x A1	63	179,2	53,6	8,8



POSTER TOTEM

- IT**
- Design sottile ed elegante
 - Cambio locandine rapido e semplice
 - Bifacciale
- ES**
- Look elegante y fino
 - Reemplazo de póster fácil y rápido
 - Doble cara
- FR**
- Conception élégante et fine
 - Changement rapide et facile des posters
 - Double-face

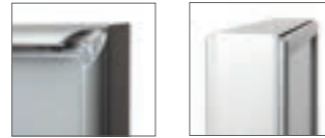

Art. nr.	DIN/Size	Dimensions (cm)				KG
		W	H	D		
TFSF2XA1	2 x A1	45	173,3	64		26,3

TRIBOARD DESIGN STANDARD

- IT**
- Opzione permanente grazie a fori predisposti sulla base
 - Adatto a un uso esterno coperto
 - Attira l'attenzione da ogni lato
- ES**
- Opción permanente gracias a los agujeros preperforados en la base
 - Adecuado para su uso en exteriores cubiertos
 - Atracción desde cualquier lado
- FR**
- Option permanente grâce à des trous pré-perçés dans la base
 - Convient pour une utilisation extérieure couverte
 - Attire l'attention de tous les côtés



Art. nr.	DIN/Size	Dimensions (cm)				KG
		W	H	D		
TBA1M	A1	74,4	181	64,5		20,7
TBA0M	A0	99,1	181	85,8		31,1

INFO POST DESIGN SLIM

- IT**
- Di facile utilizzo
 - Economico
 - Facile accesso alla struttura
- ES**
- Fácil de usar
 - Bajo coste
 - Construcción con deslizamiento cómodo
- FR**
- Facile à utiliser
 - Economique
 - Conception pratique à glissière



Art. nr.	DIN/Size	Dimensions (cm)				KG
		W	H	D		
IPOA4	A4	26	134,2	26		3,9
IPUA4	A4	26	131,5	26		2,7

SHELF P3

Accessory for Info Board Design Standard and Multipocket Display



- IT**
- Ripiano a leggido in acciaio verniciato per 3 brochure in formato A4
- ES**
- 3x estante para folletos de acero pintado en formato A4
- FR**
- 3x étagère brochure au format A4 en acier peint

Art. nr. P3

SHELF P3I

Accessory for Info Pole Design Standard



- IT**
- Ripiano per Espositore a leggido da pavimento Design Standard
- ES**
- Estante para el info pole de diseño estándar
- FR**
- Étagère pour poteau d'information dessin standard

Art. nr. P3I

Smart Line Digital A-Board (p. 75/ch. 4) and Info Post Design Slim, Ipo (p. 32/ch. 1)





APPENDO E-CLIP KIT

- IT**
- Montaggio semplice e veloce
 - Sistema espositivo a cavetto con 5 tasche in metacrilato formato A4
 - Include fissaggi e morsetti tasche
- ES**
- Montaje rápido y fácil
 - Sistema de cables con 5 carpetas de metacrilato de tamaño DIN A4
 - Incluye pinzas y fijación
- FR**
- Rapide et facile à assembler
 - Système d'affichage avec câble 5 pochettes A4 en acrylique
 - Fixations et pinces de pochettes incluses



Art. nr.	Dimensions (cm)			
	W	H	D	KG
APPECDKIT	25,5	400	1	2,4

Poster display is suitable in both orientations, portrait and landscape



2. TEXTILE FRAMES

Cornici per tessuto
Marco Textil
Cadres Textiles

Textile Frames in combination with silicone edge graphics (SEG) create a stunning visual impact. A minimalistic display solution with a frameless appearance. Optional internal illumination using LED lighting. Easy to install on site and no tools required to exchange the graphics.

INDEX

2.1 Textile Frames **40**
Cornici per tessuto
Marco Textil
Cadres Textiles

- FRAMELESS APPEARANCE DUE TO THE FLAT SIDED ALUMINIUM FRAME
- EASY GRAPHIC EXCHANGE WITHOUT TOOLS OR THE NEED TO REMOVE FROM THE WALL
- INTERNAL ILLUMINATION USING CONTINUOUS LED LIGHTING

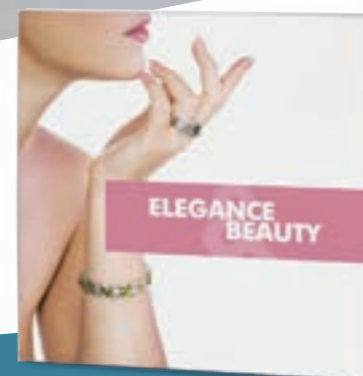

GOOD



TEXTILE FRAME WALL MODEL / LED

- Classic SEG frame design with only 30 mm depth for non-illuminated solutions
- 75 mm depth LED version contains Fresnel LED lenses that are pre-mounted at inner side of the profile
- Very easy attachment to the wall with direct mounting holes (non-LED) or steel wall mounts (with LED)



BETTER



TEXTILE FRAME SUSPENDED MODEL / LED

- Double-sided tension frame for hanging from the ceiling
- LED version contains Fresnel LED lenses that are pre-mounted at inner side of the profile
- Including hanging hooks and 2 m steel cable



BEST



TEXTILE FRAME ELEGANT BLACK

- Stylish and unique black thin profile of 22 mm
- Delivered assembled
- Great for hospitality, retail or office market



'ADVERTISEMENT IN EVERY SIZE'

TENSIONED FABRIC SYSTEM

Take your advertising to the next level with the Textile Frames. The minimalist display solution consists of a flat sided aluminium frame and tensioned fabric graphic with silicone edges. Important to know: the solution should only be used indoors. The Textile Frames are available in various models that will fulfill your wishes: illuminated, non-illuminated, single-sided and double-sided, freestanding, wall mounted or ceiling suspended. Every solution in your suitable size. From a small solution to a larger LED illuminated custom size solution for wall and freestanding applications. The depth of the profile is the main difference.



CONNECT TO IMPRESS

Textile Frames can be used both individually and segmented, allowing you to connect them in series to achieve stunning visual displays such as walls and backdrops. In that case additional supporting profiles are used inside the frame, behind the fabric. Segmented constructions allow for larger frame sizes with the inclusion of additional connectors, screws and bases.

EASY TO USE

Another important advantage is that the Textile Frames are an easy to use product. The solution can easily be installed on site.

CHANGE YOUR FABRIC GRAPHICS

The graphics can be exchanged without tools or the need to remove the solution from the wall. Fabric graphics are not included with the product but can be requested separately. Prices for all variations are available on request.

TEXTILE FRAME TOWER

NEW

- IT**
 - Espositore a torre a quattro lati
 - Un'attrazione per gli spazi pubblici
 - Leggero ma robusto
- ES**
 - Expositor a cuatro caras
 - Espectacular para espacios públicos
 - De estructura ligera pero robusta
- FR**
 - Tour de présentation à quatre faces
 - Un coup de cœur dans les espaces publics
 - Léger, mais robuste



Art. nr.	DIN/Size	Dimensions (cm)			
		W	H	D	KG
TFRTOWER60x200	60 x 200	60	200,8	66	10,5
TFRTOWER85x200	85 x 200	85	200,8	91	10,9
TFRTOWER100x200	100 x 200	100	200,8	106	11,4



Other sizes and profile depths available on request

TEXTILE FRAME SUSPENDED MODEL / LED

- IT**
 - Cornice con Tessuto in tensione bifacciale per fissaggio al soffitto
 - La versione LED contiene lenti LED Fresnel che sono preassemblate nella parte interna del profilo
 - Include ganci di montaggio e cavo d'acciaio da 2 m
- ES**
 - Marco tensado de doble cara para colgar del techo
 - La versión LED incluye lentes LED Fresnel que están premontadas en el lado interno del perfil
 - Incluye ganchos para colgar y cable de acero de 2 m
- FR**
 - Cadre de tension double face pour suspension au plafond
 - La version LED comprend des diodes LED Fresnel préinstallées sur la face intérieure du profil
 - Crochets de suspension et câble en acier de 2 m inclus



Art. nr.	DIN/Size	Dimensions (cm)			
		W	H	D	KG
TFR50HA1	A1	59,4	84,1	5	4
TFR50HA0	A0	84,1	118,9	5	5,3
TFR50H200x100	200 x 100	200	100	5	8,1

LED					
Art. nr.	DIN/Size	Dimensions (cm)			
		W	H	D	KG
TFR90HA1LED	A1	59,4	84,1	9	5,8
TFR90HA0LED	A0	84,1	118,9	9	7,2
TFR90H200x100LED	200 x 100	200	100	9	11,1



Other sizes and profile depths available on request

TEXTILE FRAME WALL MODEL / LED

- IT**
 - Design cornice SEG classico con solo 30 mm di profondità per soluzioni non illuminate
 - La versione LED profonda 75 mm contiene lenti LED Fresnel che sono preassemblate nella parte interna del profilo
 - Fissaggio alla parete molto semplice con fori per montaggio diretto (non LED) o montaggio a parete in acciaio (con LED)
- ES**
 - Diseño clásico del marco SEG con sólo 30 mm de profundidad para soluciones no iluminadas
 - La versión LED de 75 mm de profundidad incluye lentes LED Fresnel premontadas en la parte interior del perfil
 - Fijación muy fácil a la pared con orificios de montaje directo (sin LED) o soportes de acero para pared (con LED)
- FR**
 - Cadre SEG classique avec une profondeur de seulement 30 mm pour les solutions non lumineuses
 - La version LED de 75 mm de profondeur contient des lentilles LED de Fresnel qui sont pré-montées sur la face intérieure du profilé
 - Fixation murale très simple grâce aux trous de fixation (sans LED) ou aux supports muraux en acier (avec LED)



Art. nr.	DIN/Size	Dimensions (cm)			
		W	H	D	KG
TFR30WA1	A1	59,4	84,1	3	1,5
TFR30WA0	A0	84,1	118,9	3	2
TFR30W200x100	200 x 100	200	100	3	2,9



Other sizes and profile depths available on request

TEXTILE FRAME FREESTANDING MODEL / LED

- IT**
 - Profilo sottile ma solido da 75 mm per pareti
 - Con o senza LED
 - Con piedini in acciaio verniciato a polvere facili da montare (RAL9006)
- ES**
 - Perfil delgado pero resistente de 75 mm para construir paredes
 - Con o sin LED
 - Con patas de acero con recubrimiento en polvo fáciles de montar (RAL9006)
- FR**
 - Profil mince, mais solide, de 75 mm pour construire des parois
 - Avec ou sans LED
 - Avec pieds en acier thermolaqués facile à monter (RAL9006)



Art. nr.	DIN/Size	Dimensions (cm)				
		W	H	D	KG	
TFR75F2xA1	2 x A1	59,4	169,4	7,5	49	7,3
TFR75F2xA0	2 x A0	84,1	239	7,5	49	9,9
TFR75F100x200	100 x 200	200	200	7,5	49	9,4

LED						
Art. nr.	DIN/Size	Dimensions (cm)				
		W	H	D	KG	
TFR120F2xA1LED	2 x A1	59,4	169,4	9	49	11
TFR120F2xA0LED	2 x A0	84,1	239	9	49	15,1
TFR120F100x200LED	100 x 200	200	200	9	49	15



Other sizes and profile depths available on request

Standard version is double-sided without LED

LED version is single-sided

TEXTILE FRAME ELEGANT BLACK

- IT**
- Profilo sottile ma robusto da 22 mm
 - Sostituzione facile e veloce della grafica senza utensili
 - Scegliete il classico argento o l'elegante ed esclusivo colore nero
- ES**
- Perfilera fina, elegante, única y de color negro de 22 mm
 - Se entrega montado
 - Idóneo en el sector de hostelería, tiendas minoristas u oficinas
- FR**
- Fin profilé noir fin de 22 mm, élégant et unique
 - Livré monté
 - Idéal pour le secteur de l'hospitalité, les commerces de détail ou les bureaux



Art. nr.	DIN/Size	Dimensions (cm)				
		W	H	D	KG	
TFR22WA2HBL	A2	42	59,4	2,2	0,7	
TFR22WA1HBL	A1	59,4	84,1	2,2	1,5	
TFR22WA0HBL	A0	84,1	118,9	2,2	2,2	
TFR22W400x400HBL	400 x 400	40	40	2,2	0,6	

- Other sizes are available on request
- Included: Wall hook



TEXTILE FRAME ELEGANT

- IT**
- Profilo sottile ma solido da 22 mm
 - Profilo classico grazie al color argento
 - Cambio facile e veloce di grafiche senza bisogno di attrezzi
- ES**
- Perfilera fina pero resistente
 - Perfilera de estilo clásico gracias al color plateado
 - Cambio de gráfica fácil y rápido sin necesidad de usar herramientas
- FR**
- Profilé mince, mais solide de 22 mm
 - Profilé classique grâce à la couleur argentée
 - Changement sans outils, facile et rapide, du tissu imprimé



Art. nr.	DIN/Size	Dimensions (cm)				
		W	H	D	KG	
TFR22WA1	A2	59,4	84,1	2,2	1,2	
TFR22WA0	A0	84,1	118,9	2,2	1,9	

- Other sizes are available on request
- Budget unassembled version





OUR READY-TO-GO DESIGNS

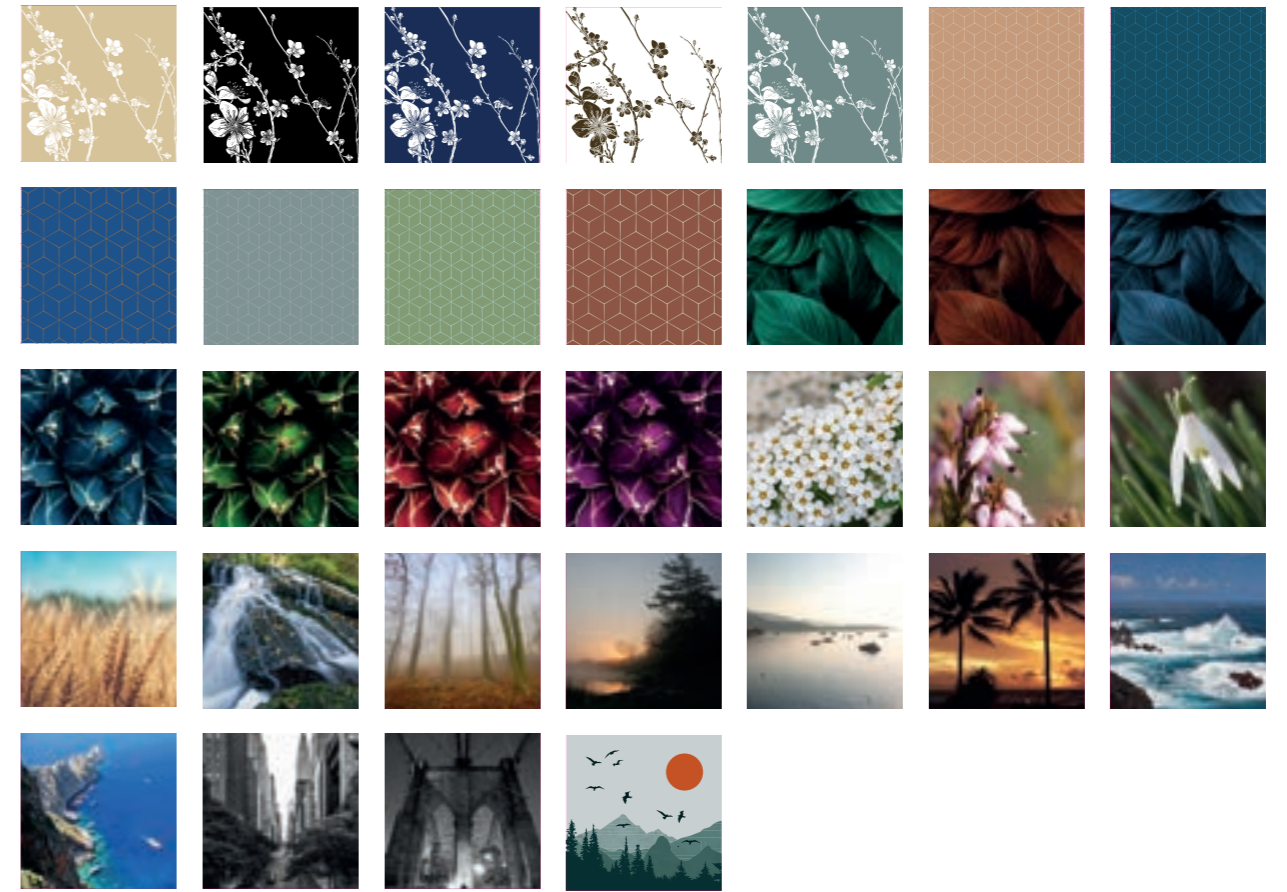

STANDARD PRINT DESIGNS

Convenient and easy! A complete set of hardware, graphic and design. No need for a graphic designer - all the print designs are pre-made and ready to use. Choose the design that fits your establishment or promotional goal. The designs are versatile and suitable for various markets: Such as hospitality, retail, public spaces, offices and events.

Curious to all our Standard Print Designs for more various products?



DIGITAL FABRIC SHOP WINDOW

- IT**
 - Facile da spostare grazie alle rotelle nella base
 - Orientamento dello schermo facile da cambiare
 - Possibilità di personalizzare la struttura con una grafica in tessuto
- ES**
 - Fácil de desplazar gracias a las ruedas de la base
 - Fácil de cambiar la orientación de la pantalla
 - Personalice la carcasa con una impresión textil
- FR**
 - Facile à déplacer grâce aux roulettes intégrées au socle
 - Changement simple de l'orientation de l'écran
 - Personnalisez le boîtier avec un visuel en textile

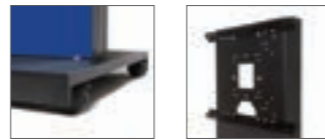

Art. nr.	Inch	Dimensions (cm)			
Universal solution (without screen)					
DISHOPTFRUNI		W	H	D	KG
		67	188,1	61	33,3
With QMR Screen					
DISHOPTFR43ESF	43"	96,8	188,9	61	40,8
DISHOPTFR50ESF	50"	109,9	192,9	61	44,3
DISHOPTFR55ESF	55"	123,5	200,6	61	48,9

- Simply upload content via USB or Wi-Fi or use optional Samsung Content Management Software
- More Digital Displays see chapter 4 Digital Displays (p. 62)
- With the latest professional Samsung screen

DIGITAL FABRIC TOTEM

- IT**
 - Personalizzazione della struttura con una grafica in tessuto
 - Sostituzione facile della grafica
 - Ordinate qui la vostra grafica per il retro del Totem digitale in tessuto
- ES**
 - Personalice la carcasa con un impresión textil
 - Fácil intercambio de impresión
 - Carcasa de lujo con diseño textil individual y monitor profesional de Samsung
- FR**
 - Personnalisez le boîtier avec un imprimé textile
 - Changement facile du motif
 - Boîtier d'écran luxueux avec conception textile individuelle et écran professionnel Samsung



Art. nr.	Inch	Dimensions (cm)			
DIFTOTEM43ESF					
	43"	W	H	D	KG
		57,5	181,9	46	43,3
DIFTOTEM50ESF					
	50"	64,9	188,5	49	47,8
DIFTOTEM55ESF					
	55"	72,5	195,3	52	49,9

- Other sizes available on request
- Simply upload content via USB or Wi-Fi or use optional Samsung Content Management Software
- More Digital Displays see chapter 4 Digital Displays (p. 62)
- With the latest professional Samsung screen

TEXTILE FRAME A-BOARD

- IT**
 - Cavalletto Pubblicitario con effetto visivo splendido
 - Aspetto senza cornice bifacciale
 - Cornice in alluminio con piedini in acciaio per la stabilità
- ES**
 - Caballete innovador con impactante efecto visual
 - Apariencia de marco inexistente a doble cara
 - Marco de aluminio con patas de acero para su estabilidad
- FR**
 - Stop-trottoir innovant avec un effet visuel époustoufflant
 - Apparence double face sans cadre
 - Cadre en aluminium avec des pieds en acier pour plus de stabilité



Art. nr.	DIN/Size	Dimensions (cm)			
ZPTFRA1	A1	W	H	D	KG
		59,4	92,7	63,9	6

- Other sizes available on request



CINEMA

CENTRAL
AMEN



3. ILLUMINATED DISPLAYS

Espositori illuminati
Tótems Publicitarios con Luz
Displays Illuminés

Steal the show with an eye-catching bright illuminated display. Powerful LEDs increase visibility and make sure your brand and message shine. Various possibilities, from hanging to freestanding displays. Clear, visible, tool-free, quick and easy. Ideal to use at any point of sale or exhibitions and events.

INDEX

3.1 LED Poster Frames **50**
Porta poster a LED
Marcos para Póster LED
Cadres LED pour Posters

3.2 Light Boxes & Illuminated Totems **56**
Cassonetti e totem luminosi
Caja de luz y Tótems Luminosos
Caissons et Totems Lumineux



GOOD

LED POSTER LIGHT BOX

- Perfect for shop window presentation
- Stunning illumination with 8 mm acrylic LED panel
- Minimal heat output, low running costs



BETTER

LED MAGNETIC POSTER FRAME

- Smart magnetic frame, poster switch in seconds
- Elegant black magnetic frame
- Bright illumination with Laser panel LED

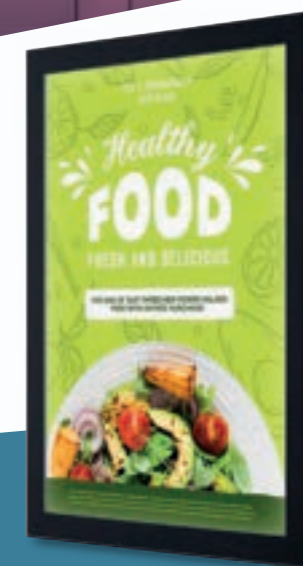

BEST

LED OUTDOOR PREMIUM POSTER CASE

- State of the art laser dot LED technology
- Premium safety glass cover
- Black ceramic printed glass for a stunning look

- GREAT LED ILLUMINATION 24/7
- EASY POSTER EXCHANGE WITH SNAP - TECHNIQUE
- ELEGANT LOOK, GREAT VARIETY OF DESIGNS AND SIZES



LED SLIDE IN FRAME SLIM

- IT**
- Design sottile e sofisticato
 - Cambio locandine rapido e semplice con scorrimento dall'alto
 - Promozione illuminata ideale adatta alle vetrine
- ES**
- Diseño fino y sofisticado
 - El cambio de poster fácil y rápido deslizándolo desde arriba
 - Promoción iluminada, ideal y adecuada para los escaparates de tiendas
- FR**
- Conception fine et sophistiquée
 - Changement rapide et facile de l'affiche en la faisant glisser depuis la partie supérieure
 - Promotion lumineuse idéale pour les vitrines des boutiques

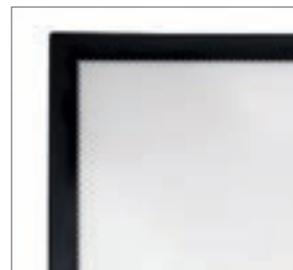

Art. nr.	DIN/Size	Dimensions (cm)			
		W	H	D	KG
SFSA3LED	A3	31,1	42,7	1	1,1
SFSA2LED	A2	43,5	60	1	2,1
SFSA1LED	A1	60,5	85	1	4,4



LED OUTDOOR POSTER CASE

- IT**
- Illuminazione intensa e omogenea
 - Cornice in alluminio anodizzato argento
 - Copertura in vetro di sicurezza
- ES**
- Iluminación clara y homogénea
 - Marco de aluminio anodizado plata
 - Cristal de seguridad
- FR**
- Eclairage lumineux et homogène
 - Cadre en aluminium argenté anodisé
 - Protection en verre de sécurité



Art. nr.	DIN/Size	Dimensions (cm)			KG
		W	H	D	
SCTL70x100PH	70x100	81,6	111,6	6,1	25,9
With gas spring					
SCTL100x140PH	100x140	111,6	151,6	6,1	43

- Splashproof IP56 certification for outdoor use
- Edge lit 12V LED lights



LED POSTER LIGHT BOX

- IT**
- Perfetta per presentazioni nelle vetrine
 - Illuminazione splendida con pannello acrilico LED da 8 mm
 - Minima emissione di calore, costi di gestione bassi
- ES**
- Perfecto para presentación en escaparate
 - Iluminación increíble con panel LED acrílico de 8 mm
 - Calentamiento mínimo, bajo consumo
- FR**
- Parfait pour la présentation en vitrine de magasin
 - Eclairage exceptionnel avec un panneau LED acrylique de 8 mm
 - Flux de chaleur minimal, faibles coûts de fonctionnement

BESTSELLER



Art. nr.	DIN/Size	Dimensions (cm)			KG
		W	H	D	
Single-sided					
PLEDA3G30	A3	33,9	46,2	2,7	2,5
PLEDA2G30	A2	46,2	63,6	2,7	4
PLEDA1G30	A1	63,6	88,3	2,7	7
PLEDA0G30	A0	88,3	123,1	2,7	11,4
PLED50x70G30	50 x 70	54,2	74,2	2,7	5
PLED70x100G30	70 x 100	74,2	104,2	2,7	9
Double-sided					
PLEDA1G30D	A1	63,9	88,6	3,3	8,9
PLEDA0G30D	A0	88,6	54,5	3,3	16,8
PLED50x70G30D	50 x 70	54,5	74,5	3,3	6,7
PLED70x100G30D	70 x 100	74,5	104,5	3,3	11,6

- Optional: Frame Hanging Kit for Double-sided version (see p. 61)
- Other colours and sizes on request



LED POSTER LIGHT BOX ECONOMY

- IT**
- Cornice a Scatto in alluminio leggera da 19 mm
 - Copertura locandina antiriflesso, stabile ai raggi UV
 - Temperatura del colore simile alla luce diurna 5000K
- ES**
- Ligero perfil de 19 mm de marco abatible de aluminio
 - Folio protector anti reflectante y resistente a rayos ultravioleta
 - Temperatura de color de luz diurna 5000K
- FR**
- Cadre en aluminium léger de 19 mm
 - Film pour poster anti-reflet, résistant aux UV
 - Température de couleur de jour 5000K



Art. nr.	DIN/Size	Dimensions (cm)			KG
		W	H	D	
PLEDEA4G19	A4	22,5	31,2	1,9	1,5
PLEDEA3G19	A3	31,2	43,5	1,9	2
PLEDEA2G19	A2	43,5	60,9	1,9	4
PLEDEA1G19	A1	60,9	85,6	1,9	6
PLEDEA0G19	A0	85,6	51,5	1,9	10
PLEDE50x70G19	50 x 70	51,5	71,5	1,9	5
PLEDE70x100G19	70 x 100	71,5	101,5	1,9	8

- Other sizes and colours on request
- Electrical connection must be indoor or via IP rated electrical box
- 220V power cable must be prepared before installation



LED OUTDOOR PREMIUM POSTER CASE FREESTANDING

- IT**
- Autoportante e bifacciale
 - Illuminazione LED intensa 24/7
 - Profilo progettato per locandine standard o grafiche in tessuto in tensione
- ES**
- Independiente y de doble cara
 - Iluminación LED durante 24/7
 - Perfil diseñado para póster estándar o impresión de tela tensada
- FR**
- Détaché et double face
 - Éclairage LED lumineux 24/7
 - Profil conçu pour une impression d'affiche standard ou de tissu de tension



Art. nr.	DIN/Size	Dimensions (cm)			KG
		W	H	D	
SCEOS1200x1800DLED	120 x 180	138,4	240	22,3	145,1

- Other sizes and colours on request
- Electrical connection must be indoor or via IP rated electrical box
- 220V power cable must be prepared before installation





LED OUTDOOR PREMIUM POSTER CASE

- IT**
 - Tecnologia punto laser LED all'avanguardia
 - Copertura in vetro di sicurezza Premium
 - Vetro stampato in ceramica nera per una resa sorprendente
- ES**
 - Tecnología LED
 - Cristal frontal templado Premium y de seguridad
 - Impresión en cerámica negra para un aspecto impresionante
- FR**
 - Technologie de pointe LED à point laser
 - Couverture en verre de sécurité de qualité
 - Imprimé en céramique noire pour un look exceptionnel



Art. nr.	DIN/Size	Dimensions (cm)			KG
		W	H	D	
SCEOSA1LED	A1	73,7	98,4	7	22,4
SCEOSA0LED	A0	98,4	133,2	7	30,8
SCEOS70x100LED	70 x 100	84,3	114,3	7	28,5
SCEOS1200x1800LED	1200 x 1800	134,3	194,3	7	68,5

- Other sizes and colours available on request
- Waterproof IP56 certification for outdoor use
- Electrical connection must be indoor or via IP rated electrical box

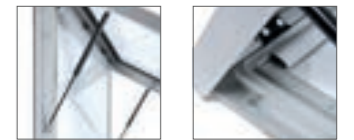

LED MAGNETIC POSTER FRAME

- IT**
 - Cornice magnetica elegante, cambio locandine in pochi secondi
 - Cornice magnetica nera elegante
 - Illuminazione intensa con pannello laser LED
- ES**
 - Marco magnético inteligente con cambio de gráfica en segundos
 - Elegante banda magnética de color negro
 - Iluminación clara con panel LED
- FR**
 - Cadre magnétique intelligent, changement de poster en quelques secondes
 - Cosse magnétique noire élégante
 - Eclairage lumineux avec panneau laser LED



Art. nr.	DIN/Size	Dimensions (cm)			KG
Single-sided					
PMLEDA2	A2	46,2	63,6	3	3,9
PMLEDA1	A1	63,6	88,3	3	6,8
PMLEDA0	A0	88,3	123,1	3	12
PMLED70x100	70 x 100	74,2	104,2	3	9

Art. nr.	DIN/Size	Dimensions (cm)			KG
Double-sided					
PMLEDA1D	A1	61,8	86,5	3	7,6
PMLEDA0D	A0	86,5	121,3	3	13,4

- Non-standard sizes on request



FLEX TOWER

- IT**
 - Lampadina spot LED intensa da 15 Watt
 - Bacheca pieghevole con cornice solida in alluminio
 - Carrello imbottito con copertura per proteggere pannelli e grafiche
- ES**
 - LED brillante de 15 vatios
 - Vitrina plegable con estructura de aluminio sólido
 - Trolley para proteger paneles e impresiones
- FR**
 - Spot LED lumineux de 15 watts
 - Valise pliable avec cadre en aluminium solide
 - Trolley renforcé avec couvercle pour protéger les panneaux et les visuels



Art. nr.	Dimensions (cm)		
	W	H	KG
FLTWR	57	206	25,5

- ➊ Including 16 translucent PVC Panels
- ➋ 24V LED Spot
- ➌ Optional: 8 extra PVC Panels for New Visuals (see p. 61)
- ➍ Perfect to combine with Flex Counter. See ch. 17 Counters and Table Covers (p. 255)

ARCUATO® POSTER LIGHT COLUMN

BESTSELLER

- IT**
 - Speciale design ovale per un effetto LED eccezionale
 - Stabile grazie alla base in acciaio verniciato a polvere
 - Profilo cornice a clip per cambiare le locandine in modo semplice
- ES**
 - Diseño ovalado especial para buen efecto LED
 - Estable gracias a la base de acero esmaltada en polvo
 - Perfiles de marco abatible para el cambio de gráfica fácil
- FR**
 - Conception ovale spéciale pour un excellent effet de LED
 - Stable grâce à la base en acier thermolaqué
 - Profils de cadres clic-clac pour changement aisé du poster



Art. nr.	DIN/Size	Dimensions (cm)			
		W	H	D	KG
TL2XA1LED	2 x A1	64,1	169,7	35	23,3
TL2X70x100LED	2 x 70 x 200	74,7	201,5	42	35



BRIGHTBOX SINGLE

- IT**
 - L'alternativa luminosa agli striscioni standard
 - La soluzione Lightbox monofacciale più conveniente
 - Le luci LED sono integrate nella parte posteriore (Pellicola Block-Out)
- ES**
 - Una alternativa de banner estándar en versión iluminada
 - Solución económica de caja de luz a una cara
 - Las luces LED están integradas en la parte trasera (film de bloqueo)
- FR**
 - L'alternative lumineuse à la bannière standard
 - Une solution de caisson lumineux simple face économique
 - Les lumières LED sont intégrées dans le dos (film de blocage)

Art. nr.	DIN/Size	Dimensions (cm)			
		W	H	D	KG
BBOXS085-200	85 x 200	85	202	35	5,5
BBOXS100-200	100 x 200	100	202	35	6
BBOXS100-250	100 x 250	100	252	35	7

- ➊ Including Block-Out Film for Backside with integrated LED lights
- ➋ Including Padded Carry Bag
- ➌ Brightbox Connector (p. 61)
- ➍ Perfect to combine with Brightbox Counter. See ch. 17 Counters and Table Covers (p. 248)





easily create 90° corners with the connector



BRIGHTBOX DOUBLE

- IT**
 - Lati magnetici collegabili con connettori in plastica per un montaggio perfetto
 - Installazione passo-passo rapida senza bisogno di attrezzi
 - Montaggio e sostituzione grafiche in tessuto semplici
- ES**
 - Laterales magnéticos conectables con conectores de plástico para una fijación perfecta
 - Instalación rápida sin herramientas y paso a paso
 - Fácil fijación y reemplazo de la impresión de tela
- FR**
 - Côtés magnétiques reliés entre eux par des connecteurs en plastique pour une fixation parfaite
 - Installation rapide sans outil et étape par étape
 - Fixation et remplacement faciles des visuels en tissu



Art. nr.	DIN/Size	Dimensions (cm)				KG
		W	H	D		
BBOXD100-200	100 x 200	100	201,5	40	9,3	
BBOXD100-250	100 x 250	100	251,5	40	11	

- Including Padded Carry Bag
- Brightbox Connector (p. 61)
- Perfect to combine with Brightbox Counter. See ch. 17 Counters and Table Covers (p. 248)





FRAME HANGING KIT

Accessory for LED Poster Light Box



- IT • Corda in metallo di alta qualità
- ES • Cuerda de metal de alta calidad
- FR • Câble métallique de qualité supérieure

Art. nr. APPCL

PVC PANELS FOR NEW VISUALS

Accessory for Flex Tower



- IT • 8 pannelli in PVC extra
- ES • 8 paneles de PVC extra
- FR • 8 panneaux PVC supplémentaires

Art. nr. FLP-SET

BRIGHTBOX CONNECTOR

Accessory for Brightbox Single and Brightbox Double



- IT • Unione di due pareti brightbox posizionate a 90 gradi
- ES • Vincule dos paredes Brightbox en un ángulo de 90 grados
- FR • Reliez deux murs Brightbox ensemble dans un angle de 90 degrés

Art. nr. BBOX-CC

🔗 Suitable for Brightbox Single and Double

BRIGHTBOX XL

- IT • Perfetto per esposizioni promozionali a breve termine
• Montaggio e sostituzione grafiche in tessuto semplici (SEG)
• Alternativa economica a Pop-Up Impress
- ES • Perfecto para promociones cortas durante las ferias
• Fácil colocación y cambio de gráfica de tela (SEG)
• Una alternativa asequible para Pop-Up Impress
- FR • Parfait pour les promotions à court terme lors des expositions
• Fixation et remplacement faciles des visuels en tissu (SEG)
• Une alternative économique pour Pop-Up Impress



Art. nr.	DIN/Size	Dimensions (cm)			
		W	H	D	KG
BBOXXL300-240	300 x 240	242	300,3	41,9	21,4

- 🔗 Great addition to the Brightbox Family
- 🔗 Perfect to combine with Brightbox Counter.
See ch. 17 Counters and Table Covers (p. 248)



4. DIGITAL DISPLAYS

Espositori Digitali
Pantallas Digitales
Afficheurs Digitales

Digital Displays offer dynamic content and real-time advertising solutions to engage customers. The professional displays provide ultra-high definition, crystal clear picture quality designed for 24/7 use. The portfolio includes indoor and outdoor Digital Totems, A-Boards, Kiosks, Wall & Hanging Panels in various sizes and colours as well as tablet holders.

- THE LATEST PROFESSIONAL QMC SAMSUNG SCREENS
- CLEAR MESSAGE AND INTERACTIVITY 24/7/365 OPERATIONAL
- USB DRIVE SOCKET, ETHERNET CONNECTION, WI-FI CONNECTIVITY

INDEX

4.1 Digital Displays **66**
Espositori Digitali
Pantallas Digitales
Afficheurs Digitales

4.2 Screen Holders and Tablet Holders **78**
Supporti per schermi
e tablet
Soportes para Pantallas
y Tablets
Supports pour écrans
et tablettes



GOOD



SMART LINE DIGITAL TOTEM

- Elegant frameless design
- Housing standard available in black or white
- Heavy base 8 mm steel plate ensuring good stability



BETTER



SMART LINE DIGITAL TOTEM RACK

- Integrated brochure rack to hold 6 x A4 printed advertising
- Fingerprint resistant paint finish
- Housing standard available in black and white

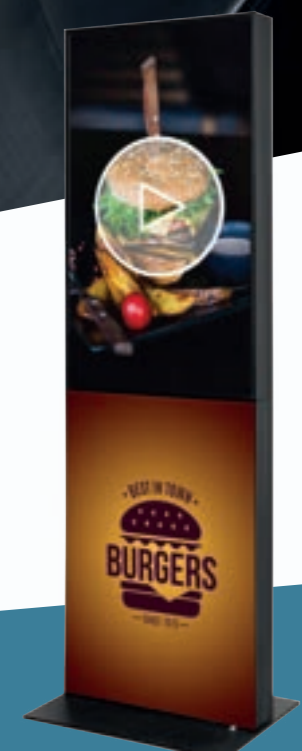

BEST



DIGITAL FABRIC TOTEM

- Personalise the housing with a textile graphic
- Easy graphic exchange
- Luxurious screen housing with individual textile design and professional Samsung screen



'DIGITAL IS THE FUTURE'

A picture is worth more than a thousand words. Let's go for more! With the Digital Display products you attract attention, tell stories and create an unforgettable impression at the right place and time. Easy, practical and extensible: those are the three keywords for the Digital Display assortment. Your wishes will be fulfilled as the Digital Displays are customisable to your requested size and preferences. Spread your message elegantly and durable.

ADAPT TO THE MOMENT

Change your message easily at any time of the day. Whether it's in the morning or during weekends, when it's raining or the sun is shining. You name it. Your message will always suit the situation. Speed won't be a problem: play your images and videos easily via Plug & Play with the USB drive, share via Wi-Fi or upgrade with Content Management System MagicINFO Cloud.

STAY IN TOUCH

Give the best and get the best: create interaction with your public. Show your e-shop, receive feedback on the spot or promote other items. It's all up to you. The displays have a safety tempered glass or plastic cover and have a heavy duty aluminium or steel construction.

EVERYWHERE AT ANY TIME

The Digital Displays are equipped with the latest professional QMC Samsung screens. There is no need to worry about missing your moment to shine, because the displays are operational 24/7, all year long. Even with the outdoor displays, you don't have to miss anything.

MEET ANY DIGITAL DESIRE

The Digital Displays are European produced. Always the solution, just around the corner! Need a different colour, size or just the housing? No worries! An R&D and production team have got you covered! We are all geared up to provide you the perfect, digital solution!

NEW



SMART LINE DIGITAL TOTEM RACK

- IT**
- Portadepliant integrato per contenere stampati pubblicitari 6 x A4
 - Verniciatura resistente alle impronte delle dita
 - Struttura standard disponibile in nero e in bianco
- ES**
- Estante para folletos integrado para contener 6 materiales publicitarios impresos en formato A4
 - Acabado en pintura resistente a huellas dactilares
 - Carcasa estándar disponible en blanco o negro
- FR**
- Le porte-brochures intégré peut contenir 6 publicités imprimées au format A4
 - Peinture résistante aux empreintes digitales
 - Boîtier de base disponible en noir ou en blanc

Art. nr.	☒	Inch	Dimensions (cm)			
			W	H	D	KG
DITTOTEMR43ESF	●	43"	57,5	181,3	46	57
DITTOTEMR43C9003ESF	○	43"	57,5	181,3	46	57

With Touch Functionality

DITTOTEMR43ESFT	●	43"	60,2	181,9	46	61,5
DITTOTEMR43C9003ESFT	○	43"	60,2	181,9	46	61,5

- Standard colour black or white, other RAL colours on request
- Branding of the totem housing on request
- ⓘ Screen is not covered with glass



SMART LINE DIGITAL TOTEM DOUBLE-SIDED

- IT**
- Due schermi per una doppia esposizione
 - Sincronizzate o mostrate diversi contenuti in movimento su entrambi i lati
 - Elegante design privo di cornice
- ES**
- Dos pantallas para doble exposición
 - Sincronice o muestre diferentes contenidos en movimiento en ambos lados
 - Elegante diseño sin marco
- FR**
- Double écran pour double affichage
 - Synchronisez ou diffusez différents contenus animés des deux côtés
 - Design élégant sans cadre



NEW

Art. nr.	☒	Inch	Dimensions (cm)			
			W	H	D	KG
DITDTOTEM43ESF	●	43"	57,5	182,2	53	74,3
DITDTOTEM50ESF	●	50"	66,2	188,8	53	85
DITDTOTEM43C9003ESF	○	43"	57,5	182,2	53	74,3
DITDTOTEM50C9003ESF	○	50"	66,2	188,8	53	85

- Housing standard available in black and white



DIGITAL TOTEM SKY

- IT**
- Design elegante, snello e open frame
 - Verniciatura resistente alle impronte delle dita
 - Porte facilmente accessibili protette da un coperchio in acciaio
- ES**
- Diseño de marco abierto fino y elegante
 - Acabado en pintura resistente a huellas dactilares
 - Puertos de fácil acceso protegidos por una tapa de acero
- FR**
- Conception du cadre élégante, mince et ouverte
 - Peinture résistante aux empreintes digitales
 - Ports facilement accessibles et protégés par un couvercle en acier



NEW

Art. nr.	Inch	Dimensions (cm)			
		W	H	D	KG
DISKYTOTEM43ESF	43"	60,3	190	60	33,2
DISKYTOTEM55ESF	55"	75,3	205,2	60	47,8

- Simply upload content via USB or Wi-Fi or use optional Samsung Content Management Software



DIGITAL SLIM TOTEM

- IT**
 - Design classico del Totem digitale
 - Vetro di sicurezza per la protezione dello schermo
 - Possibilità di installare la base senza che sia visibile
- ES**
 - Diseño clásico de tótem digital
 - Cristal de seguridad templado para proteger la pantalla
 - Posibilidad de montar la base de forma invisible en el suelo
- FR**
 - Design classique du Totem numérique
 - Verre de sécurité trempé pour protéger l'écran
 - La base peut être fixée au sol en toute discrétion

Art. nr.	Inch	Dimensions (cm)			
		W	H	D	KG
DISTOTEM43ESF	43"	71,9	202	50	85
DISTOTEM50ESF	50"	78,9	202	70	97,8
DISTOTEM55ESF	55"	87,3	202	70	108,1
DISTOTEM65ESF	65"	105,7	222	80	147,9

With Touch Functionality					
DISTOTEM43ESFT	43"	71,9	202	50	86
DISTOTEM50ESFT	50"	78,9	202	70	99
DISTOTEM55ESFT	55"	87,3	202	70	109
DISTOTEM65ESFT	65"	105,7	222	80	148,9

- Standard colour black, other RAL colours on request
- Optional: Touch foil can be applied to provide touch functionality
- Only 70 mm deep totem

EXTENDED RANGE



BESTSELLER

EXTENDED RANGE



DIGITAL DOUBLE-SIDED TOTEM

- IT**
 - Doppio schermo per una doppia esposizione
 - Sincronizzate o proiettate diversi contenuti animati su entrambi i lati
 - Vetro rinforzato per la protezione dello schermo
- ES**
 - Dos pantallas para doble exposición
 - Sincronice o muestre diferentes contenidos en movimiento en ambos lados
 - Cristal de seguridad templado para proteger la pantalla
- FR**
 - Double écran pour double affichage
 - Synchronisez ou diffusez différents contenus animés des deux côtés
 - Protection de l'écran en verre de sécurité trempé

Art. nr.	Inch	Dimensions (cm)			
		W	H	D	KG
DIDTOTEM43ESF	43"	71,9	202	65	117
DIDTOTEM50ESF	50"	78,9	202	70	129,5
DIDTOTEM55ESF	55"	87,3	202	70	147
DIDTOTEM65ESF	65"	106,1	222	80	150

With Touch Functionality					
DIDTOTEM43ESFT	43"	71,9	202	65	119
DIDTOTEM50ESFT	50"	78,9	202	70	131
DIDTOTEM55ESFT	55"	87,3	202	70	149
DIDTOTEM65ESFT	65"	106,1	222	80	152

- Standard colour black, other RAL colours on request
- Optional: Touch foil can be applied to provide touch functionality

EXTENDED RANGE



SMART LINE DIGITAL TOTEM

- IT**
 - Design elegante e senza cornice
 - Struttura standard disponibile in bianco e nero
 - Base robusta in acciaio da 8 mm per una buona stabilità
- ES**
 - Elegante diseño sin marco
 - Carcasa estándar disponible en blanco o negro
 - Base pesada de chapa de acero de 8 mm que garantiza una buena estabilidad
- FR**
 - Design élégant sans cadre
 - Boîtier de base disponible en noir ou en blanc
 - Base lourde en tôle d'acier de 8 mm pour une bonne stabilité

Art. nr.	Inch	Dimensions (cm)			
		W	H	D	KG
DITTOTEM43ESF	43"	57,5	181,3	46	55
DITTOTEM55ESF	55"	72,5	200,1	52	88
DITTOTEM43C9003ESF	43"	57,5	181,3	46	55
DITTOTEM55C9003ESF	55"	72,5	200,1	52	88

- Standard colour black or white, other RAL colours on request
- Branding of the totem housing on request
- Screen is not covered with glass



- Simply upload content via USB or Wi-Fi or use optional Samsung Content Management Software

OUTDOOR DIGITAL TOTEM

- IT**
- Adatto ad un uso esterno da -30°C a 50°C grazie alle sue ventole di raffreddamento
 - Resistente alle intemperie grazie alla certificazione IP56
 - Installazione fissa in calcestruzzo necessaria
- ES**
- Totalmente a prueba de uso en exteriores de -30°C a 50°C gracias a los ventiladores de refrigeración
 - Resistencia a la intemperie gracias a la certificación IP56
 - Requiere instalación fija en hormigón
- FR**
- Résistance complète en extérieur de -30°C à 50°C grâce à des ventilateurs pour le refroidissement
 - Résistance aux intempéries grâce à la certification IP56
 - Installation fixe sur béton nécessaire

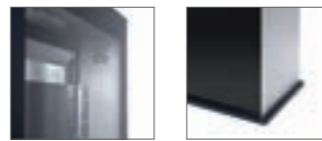

Art. nr.	Inch	Dimensions (cm)			
		W	H	D	KG
DIOTOTEM55ESF	55"	85,3	200,9	21	146,1

- With ground fixing plate and electrical connection
 - Innox front and back metal sheets
 - Outdoor display is without WiFi connection
- Simply upload content via USB or use optional Samsung Content Management Software



Digital Fabric Shop Window (p. 72/ch. 4)



OUTDOOR DIGITAL TOTEM DESIGN

- IT**
- Adatto ad un uso esterno da -30°C a 50°C grazie alle sue ventole di raffreddamento
 - Resistente alle intemperie grazie alla certificazione IP56
 - Installazione fissa in calcestruzzo necessaria
- ES**
- Totalmente a prueba de uso en exteriores de -30°C a 50°C gracias a los ventiladores de refrigeración
 - Resistencia a la intemperie gracias a la certificación IP56
 - Requiere instalación fija en hormigón
- FR**
- Résistance complète en extérieur de -30°C à 50°C grâce à des ventilateurs pour le refroidissement
 - Résistance aux intempéries grâce à la certification IP56
 - Installation fixe sur béton nécessaire

Art. nr.	Inch	Dimensions (cm)			
		W	H	D	KG
DIOTOTEMD55ESF	55"	120	200	12	73,1

- With IP56 certification
- Simply upload content via USB or use optional Samsung Content Management Software



DIGITAL FABRIC SHOP WINDOW

- IT**
 - Facile da spostare grazie alle rotelle nella base
 - Orientamento dello schermo facile da cambiare
 - Possibilità di personalizzare la struttura con una grafica in tessuto
- ES**
 - Fácil de desplazar gracias a las ruedas de la base
 - Fácil de cambiar la orientación de la pantalla
 - Personalice la carcasa con una impresión textil
- FR**
 - Facile à déplacer grâce aux roulettes intégrées au socle
 - Changement simple de l'orientation de l'écran
 - Personnalisez le boîtier avec un visuel en textile



Art. nr.	Inch	Dimensions (cm)			
		W	H	D	KG
Universal solution (without screen)					
DISHOPTFRUNI		67	188,1	61	33,3
With QMC Screen					
DISHOPTFR43ESF	43"	96,8	188,9	61	40,8
DISHOPTFR50ESF	50"	109,9	192,9	61	44,3
DISHOPTFR55ESF	55"	123,5	200,6	61	48,9

More Fabric (SEG) systems see chapter 2 Textile Frames (p. 36)



DIGITAL WALL PANEL

- IT**
 - Vetro di sicurezza per la protezione dello schermo
 - Modello standard con orientamento verticale. Orientamento orizzontale su richiesta
 - Facile da installare alla parete
- ES**
 - Cristal de seguridad templado para la protección de la pantalla
 - Estándar en orientación vertical. Horizontal bajo pedido
 - Fácil montaje en pared
- FR**
 - Verre de sécurité trempé pour la protection de l'écran
 - Orientation standard mode portrait. Orientation paysage sur demande
 - Montage mural simple



Art. nr.	Inch	Dimensions (cm)			
		W	H	D	KG
DIWALL43ESF	43"	70,3	111,3	12,2	38
DIWALL50ESF	50"	77,7	124,7	12,2	45,5
DIWALL55ESF	55"	86,1	138,6	12,2	54,1

- Standard is vertical, horizontal on request
- Standard colour black, other RAL colours on request
- Optional: Touch foil can be applied to provide touch functionality



DIGITAL FABRIC TOTEM

- IT**
 - Personalizzazione della struttura con una grafica in tessuto
 - Sostituzione facile della grafica
 - Ordinate qui la vostra grafica per il retro del Totem digitale in tessuto
- ES**
 - Personalice la carcasa con un impresión textil
 - Fácil intercambio de impresión
 - Carcasa de lujo con diseño textil individual y monitor profesional de Samsung
- FR**
 - Personnalisez le boîtier avec un imprimé textile
 - Changement facile du motif
 - Boîtier d'écran luxueux avec conception textile individuelle et écran professionnel Samsung



Art. nr.	Inch	Dimensions (cm)			
		W	H	D	KG
DIFTOTEM43ESF	43"	57,5	181,9	46	43,3
DIFTOTEM50ESF	50"	64,9	188,5	49	47,8
DIFTOTEM55ESF	55"	72,5	195,3	52	49,9

More Fabric (SEG) systems see chapter 2 Textile Frames (p. 36)



SMART LINE DIGITAL PANEL

- IT**
 - Design elegante e senza cornice
 - Montaggio a parete facile
 - Adatta sia per orientamento verticale che orizzontale
- ES**
 - Elegante diseño sin marco
 - Fácil montaje en pared
 - Apto tanto para orientación vertical como horizontal
- FR**
 - Design élégant sans cadre
 - Montage mural facile
 - Peut être utilisé à la fois en orientation portrait et paysage



Art. nr.	Inch	Dimensions (cm)			
		W	H	D	KG
DITWALL43ESF	43"	56,5	97,6	7,4	20
DITWALL50ESF	50"	65,2	113	7,8	27
DITWALL43C9003ESF	43"	56,5	97,6	7,4	20
DITWALL50C9003ESF	50"	65,2	113	7,8	27

- Standard colour black or white, other RAL colours on request
- Optional: Suspension Set for suspension on ceiling (see p. 77)
- Suitable in both orientations, portrait and landscape

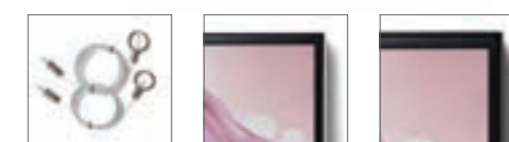

NEW



DIGITAL A-BOARD SPECTRUM

- IT**
- Schermo comodamente posizionato ad altezza occhi
 - Facile da trasportare e spostare grazie alle rotelle
 - Verniciatura resistente alle impronte delle dita

- ES**
- Pantalla ubicada de forma cómoda a la altura de los ojos
 - Fácil de transportar y desplazar con ruedas
 - Acabado en pintura resistente a huellas dactilares

- FR**
- Écran positionné de façon pratique, à hauteur de regard
 - Facile à transporter et à déplacer grâce aux roulettes
 - Peinture résistante aux empreintes digitales



Art. nr.	Inch	Dimensions (cm)			
		W	H	D	KG
DIAS43ESF	43"	56,4	158,7	46,1	23,5
DIAS43C9003ESF	43"	56,4	158,7	46,1	23,5

Perfect for events, showrooms, hospitality and POS



SMART LINE DIGITAL A-BOARD

BESTSELLER

- IT**
- Trasporto e spostamenti facili grazie alle ruote
 - Design elegante senza cornice
 - Ideale per eventi, showroom, ospitalità e POS
- ES**
- Fácil de transportar y desplazar con ruedas
 - Elegante diseño sin marco
 - Perfecto para eventos, salas de exposiciones, hostelería y puntos de venta
- FR**
- Facile à transporter et à déplacer grâce aux roulettes
 - Design élégant sans cadre
 - Idéal pour les événements, les showrooms, l'hôtellerie et la PLV



Art. nr.	Inch	Dimensions (cm)			
		W	H	D	KG
DIAT43ESF	43"	56	123,8	42,6	32
DIAT43C9003ESF	43"	56	123,8	42,6	32

- Standard colour black or white, other RAL colours on request
- Branding of the A-Board housing on request
- Wheels included for easy transport



DIGITAL SHOP WINDOW DISPLAY

- IT**
- Disponibile con o senza schermo digitale
 - Orientamento dello schermo facile da cambiare
 - Lato posteriore liscio con ventilazione

- ES**
- Elija con o sin pantalla digital
 - Fácil de cambiar la orientación de la pantalla
 - Parte trasera con acabado liso y ventilación

- FR**
- Au choix, avec ou sans écran numérique
 - Changement facile de l'orientation de l'écran
 - Face arrière lisse et ventilée



Art. nr.	Inch	Dimensions (cm)			
Universal solution (without screen)					
DISHOPUNI		80	180	50	45,5
With QMC Screen					
DISHOP43ESF	43"	96,8	191,9	50	55,5
DISHOP50ESF	50"	109,9	195,5	50	59
DISHOP55ESF	55"	123,5	199,4	50	63,5



GET THE FULL EXPERIENCE AND GO TO WWW.DIGITAL-COUNTER.COM

NEW



DIGITAL COUNTER FUTURO

- IT**
- Comptoir premium avec affichage digital en orientation paysage ou portrait
 - Assemblage facile
 - Modèle standard avec visuels noirs latéraux (SEG)
- ES**
- Mostrador premium con presentación digital en orientación horizontal
 - Fácil de montar
 - De serie con gráficos negros en los laterales (SEG)
- FR**
- Comptoir premium avec affichage numérique en orientation paysage
 - Assemblage facile
 - Modèle standard avec visuels noirs latéraux (SEG)



Art. nr.	Inch	Dimensions (cm)			
		W	H	D	KG
DICOUNTER32ESF	32"	72	92,8	44,5	23,1
DICOUNTER55ESF	55"	92,8	134,5	40,5	45,5

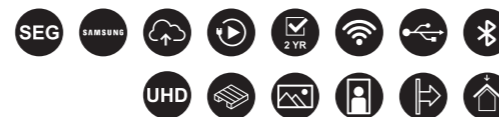

DIGITAL KIOSK

- IT**
- Angolo a 20 gradi per facilitare la visibilità del contenuto
 - Vetro di protezione per la protezione dello schermo
 - Ideale per musei, centri commerciali o spazi pubblici
- ES**
- Ángulo de 20 grados para facilitar la lectura del contenido
 - Cristal de seguridad templado para proteger la pantalla
 - Perfecto para su uso en museos, centros comerciales o espacios públicos
- FR**
- Inclinaison de 20 degrés facilitant la lecture du contenu
 - Verre de sécurité trempé pour protéger l'écran
 - Idéal dans les musées, les centres commerciaux ou les espaces publics

Art. nr.	Inch	Dimensions (cm)			
		W	H	D	KG
DIKIOSK43ESF	43"	110	119,8	71,8	111,6
DIKIOSK50ESF	50"	124,8	122,8	81,8	128,2

With Touch Functionality

DIKIOSK43ESFT	43"	110	119,8	71,8	111,6	NEW
DIKIOSK50ESFT	50"	124,8	122,8	81,8	128,2	NEW

- Other RAL colours available on request
- Branding of the kiosk housing on request
- Optional: Touch foil can be applied to provide touch functionality

EXTENDED RANGE
NEW DESIGN



SUSPENSION SET

Accessory for Smart Line Digital Panel



- IT**
- Kit di montaggio certificato TÜV per sospensione da soffitto
- ES**
- Set de suspensión para suspensión de techo con certificado TÜV
- FR**
- Kit de suspension pour suspension au plafond certifié TÜV

Art. nr. DITWALLHS

- All Digital Displays with article code ending in 'ESF' include latest professional Samsung screen
- Simply upload content via USB or Wi-Fi or use optional Samsung Content Management Software

VESA MOUNT FREESTANDING

- IT**
 - Supporto per monitor VESA universale fino a 22"
 - Piastra di fissaggio VESA universale per espositori multimediali e schermi
 - Inclinazione regolabile
- ES**
 - Para monitores hasta 22"
 - Sujeción VESA universal para pantallas y displays multimedia
 - Posición de inclinación ajustable
- FR**
 - Support de moniteur VESA universel jusqu'à 22"
 - Plaque de fixation VESA universelle pour écrans et affichages multimédia
 - Inclinaison réglable



Art. nr.	Inch	Dimensions (cm)			
		W	H	D	KG
DSVESA	10"	45	117	45	13,5

Screen not included

TRIGRIP STAND STEEL

- IT**
 - Supporto tablet con design Premium e struttura in acciaio
 - Orientabile sia in verticale sia in orizzontale
 - Con serratura
- ES**
 - Un soporte para tablet con el diseño premium y con la construcción de acero
 - Orientación horizontal y vertical
 - Con el cierre
- FR**
 - Support pour tablette de qualité supérieure avec structure en acier
 - Pour orientation portrait et paysage
 - Verrouillable



Art. nr.	Inch	Dimensions (cm)			
		W	H	D	KG
DTSTGL10	10"	30	115	30	6

Steel frame suitable for branding with screen printing or adhesive foil

TRIGRIP FREESTANDING

- IT**
 - Supporto tablet da pavimento con sistema Trigrip
 - Colonnina in alluminio con solida base in acciaio per un'ottima stabilità
 - Supporto regolabile adatto a serratura Kensington
- ES**
 - Soporte para tableta de pie con sistema Trigrip
 - Poste de aluminio con base de acero pesado para una gran estabilidad
 - Soporte ajustable listo para bloqueo Kensington
- FR**
 - Support de tablette sur pied avec système Trigrip
 - Poteau en aluminium avec base lourde en acier pour une grande stabilité
 - Support réglable prêt pour le verrouillage Kensington



Art. nr.	Inch	Dimensions (cm)			
		W	H	D	KG
DTSTGS10	10"	33	101,8	33	6,2
DTSTGS13	13"	33	105,1	33	6,2

Device not included

TRIGRIP FREESTANDING TELESCOPIC

- IT**
 - Altezza regolabile da 740 mm a 1300 mm
 - Ottima stabilità
 - Adatto a serratura Kensington
- ES**
 - Altura regulable desde 740 mm hasta 1300 mm
 - Buena estabilidad
 - Listo para cerradura Kensington
- FR**
 - Hauteur réglable de 740 mm à 1300 mm
 - Excellente stabilité
 - Prêt pour le verrouillage Kensington



Art. nr.	Inch	Dimensions (cm)			
		W	H	D	KG
DTSTGT10	10"	33	107	33	6,7
DTSTGT13	13"	33	110	33	6,7

Device not included

SLIMCASE WALL FIXED

- IT**
 - Supporto tablet per modelli Apple iPad 10.2" (2019) e Samsung Galaxy Tab 10.1" (2019)
 - Pronta per il montaggio, fori preimpostati per fissaggio con viti
 - Si può posizionare sia in orizzontale sia in verticale
- ES**
 - Porta tablet para los modelos Apple iPad 10.2" (2019) y Samsung Galaxy Tab 10.1" (2019)
 - Listo para el montaje – agujeros perforados para tornillos de fijación
 - Montaje en vertical u horizontal
- FR**
 - Support de tablette pour les modèles Apple iPad 10.2" (2019) et Samsung Galaxy Tab 10.1" (2019)
 - Prêt à monter – Trous prépercés pour la fixation à vis
 - Fixation en orientation portrait ou paysage



Art. nr.	Inch	Dimensions (cm)			
		W	H	D	KG
Apple 10,2" DTSA20WFC9005	10"	19,6	31,7	4	2,1
Samsung 10,1" DTSS20WFC9005	10"	17,2	31,2	4	2,1

Device not included

Other RAL colours available on request



SAMSUNG

BENEFITS OF DIGITAL DISPLAYS

- ✦ Flexible advertising, change your content anytime you want
- ✦ Draw attention with Samsung's high resolution screens boasting vibrant colours
- ✦ Save time and resources, manage and update content remotely
- ✦ Cost efficiency on the long run
- ✦ 2 years of warranty
- ✦ Plug & Play your content easily to every digital
- ✦ Option to add 24/7 Samsung support into MagicINFO Cloud
- ✦ Communicate quickly and increase audience engagement
- ✦ Suitable for various environments like retail, hospitality, events and public spaces
- ✦ European production



5. PAVEMENT SIGNS

Espositori per marciapiedi
Señales de Pavimento
Chevalets de Trottoir

Pavement signs are the most common and effective advertising method to get people to notice your business. At the entrance of your store, restaurant or other public place. A-Boards and Windtalkers are commonly used in pedestrian and high traffic areas. Easy to set up and available in a wide variety of styles, shapes, materials and sizes.



INDEX

5.1 A-Boards Cavalletti Caballette Pubblicitario Stop-Trottoir	84
5.2 Windtalkers Windtalkers Paneles Involcables Exterior Stop-Trottoir	92

- **GOOD STABILITY DUE TO ALUMINIUM FEET OR FILLABLE BASE**
- **INDOOR, OUTDOOR AND HEAVY WEATHER RESISTANT OPTIONS**
- **EASY POSTER EXCHANGE WITH SNAP - TECHNIQUE**



GOOD

32 MM PROFILE A-BOARD

- Best selling outdoor pavement sign
- Stable metal back wall
- UV resistant anti-glare protection foil



BETTER

DESIGN COMPASSO® A-BOARD

- Unique 37 mm aluminium double profile
- Premium design with the curved top frame
- Special designed foil for poster protection



BEST

DESIGN A-BOARD PRIME

- High quality A-Board with special safety features
- Safety catch folding mechanism
- Non corrosive metal back panel

32 MM PROFILE A-BOARD

BESTSELLER

- IT**
- L'espositore a cavalletto per esterni più venduto
 - Stabile parete posteriore in metallo
 - Pellicola protettiva antiriflesso resistente ai raggi UV
- ES**
- El caballete publicitario de suelo más vendido
 - Trasera metálica y estable
 - Folio protector antirreflejos y contra rayos ultravioleta
- FR**
- Stop trottoir extérieur le plus vendu
 - Panneau arrière stable en métal
 - Film de protection antireflet résistant aux UV

Art. nr.	DIN/Size	Dimensions (cm)			
		W	H	D	KG
Mitred corners					
ZPA2G32ME	A2	46,5	99,9	68,3	4,5
ZPA1G32ME	A1	63,9	109,4	74,4	9,2
ZPA0G32ME	A0	88,6	138	92,5	15,4
ZP50x70G32ME	50x70	54,5	99,9	74,4	6,6
ZP70x100G32ME	70x100	92,5	138	74,5	10,7
ZPA1G32MEC9005	A1	63,9	109,4	74,4	9,2
ZP50x70G32MEC9005	50x70	54,5	99,9	74,4	6,6
ZP70x100G32MEC9005	70x100	92,5	138	74,4	10,7
Rounded corners					
ZPA2R32ME	A2	46,5	102,5	68,3	5,8
ZPA1R32ME	A1	63,9	112	74,4	8,7
ZPA0R32ME	A0	88,6	140,6	92,5	15,1
ZP50x70R32ME	50x70	54,5	112	74,4	6,4
ZP70x100R32ME	70x100	74,5	140,6	92,5	10,2
ZP100x140R32ME	100x140	104,5	156,8	102,8	20,1



Optional: Topcard + Wireframe Set for size A1 and Brochure Basket (see p. 87)

32 MM PROFILE WEATHER RESISTANT A-BOARD

- IT**
- Per un utilizzo esterno
 - Fori di drenaggio sul profilo inferiore
 - Tasca completamente sigillata (antispruzzo) resistente alle intemperie
- ES**
- Para uso en exteriores
 - Marco inferior con orificios como sistema de desagüe
 - Bolsa para póster totalmente sellada resistente a la intemperie (a prueba de salpicaduras)
- FR**
- Pour l'extérieur
 - Trous de drainage dans le profil inférieur
 - Sac pour affiche entièrement scellé résistant aux intempéries (éclaboussures)



Art. nr.	DIN/Size	Dimensions (cm)			
		W	H	D	KG
ZPA2R32MEWR	A2	46,5	102,5	68,3	8,9
ZPA1R32MEWR	A1	63,9	112	74,4	11,1
ZP50x70R32MEWR	50x70	54,5	112	68,3	8,4
ZP70x100R32MEWR	70x100	68,3	140,6	74,5	13,5

84 See accessory page for options (p. 87)

Graphic available

DESIGN COMPASSO® A-BOARD

- IT**
- Profilo doppio in alluminio da 37 mm unico
 - Design premium con cornice superiore curva
 - Progettato appositamente per la protezione delle coperture delle locandine
- ES**
- Doble marco especial de aluminio de 37 mm
 - Diseño excepcional de marco superior curvado
 - Folio protector diseñado especialmente para mejor protección
- FR**
- Profil double en aluminium unique de 37 mm
 - Conception haut de gamme avec cadre supérieur incurvé
 - Film spécialement conçu pour la protection des posters



Art. nr.	DIN/Size	Dimensions (cm)			
		W	H	D	KG
ZPC2A1	A1	66	115	78	16,4

Optional: 3 mm foamed PVC Topcard and Brochure Basket suitable for Compasso® (see p. 87)

DESIGN A-BOARD PRIME

- IT**
- Cavalletto di alta qualità con particolari caratteristiche di sicurezza
 - Meccanismo di chiusura di sicurezza
 - Pannello posteriore in metallo non corrosivo
- ES**
- Caballete de alta calidad con prestaciones de seguridad mejoradas
 - Sistema de plegado seguro
 - Trasera metálica antioxidante
- FR**
- Stop-trottoir de haute qualité avec des caractéristiques de sécurité spéciales
 - Mécanisme de pliage de loquet de sécurité
 - Panneau arrière en métal non corrosif



Art. nr.	DIN/Size	Dimensions (cm)			
		W	H	D	KG
ZPZA1	A1	65,2	110	76	12,3
Outdoor					
ZPZA1WR	A1	65,2	110	76	14,2

85 See accessory page for options (p. 87)

Graphic available

DESIGN COMPASSO® A-BOARD LOGO

- IT**
 - Cavalletto Premium con un'eccezionale durevolezza
 - Opzione logo sulla parte superiore unica
 - Perfetto per le entrate dei negozi e dei centri commerciali
- ES**
 - Caballete Premium extremadamente duradero
 - Espacio extra para su logo
 - Perfecto para las entradas de las tiendas y centros comerciales
- FR**
 - Stop-trottoir haut de gamme avec une durabilité extrême
 - Option unique de logo sur la partie supérieure
 - Parfait pour les entrées de magasin et les centres commerciaux



Art. nr.	DIN/Size	Dimensions (cm)			
		W	H	D	KG
ZPC1A1	A1	66	79,3	79,3	18,5
Integrated Header Panel					
	A1	64,7	20,4		

➊ Integrated Header Panel included

25 MM PROFILE A-BOARD DESIGN STANDARD

- IT**
 - Bestseller
 - Utilizzo interno o in aree coperte
 - Bifacciale
- ES**
 - Best seller
 - Uso interior o en zonas cubiertas
 - De doble cara
- FR**
 - Best-seller
 - Utilisation en intérieur ou zones couvertes
 - Double-face



Art. nr.	DIN/Size	Dimensions (cm)			
		W	H	D	KG
ZPA2G25	A2	45,1	98	67,4	5
ZPA1G25	A1	62,5	107,5	73,6	6,8
ZP50x70G25	50 x 70	98	67,4	53,1	5,9
ZP70x100G25	70 x 100	91,7	136,1	73,1	9
ZPA2R25	A2	100,6	67,4	45,1	4,7
ZPA1R25	A1	73,6	110,1	62,5	6,6
ZP50x70R25	50 x 70	53,1	100,6	67,4	5,7
ZP70x100R25	70 x 100	73,1	138,1	91,7	8,8

➋ Optional: Brochure Basket (see p. 87)

86 ➊ See accessory page for options (p. 87)

➋ Graphic available

SPLASHPROOF POSTER BAG

Accessory for A-Boards and all Snap Frames

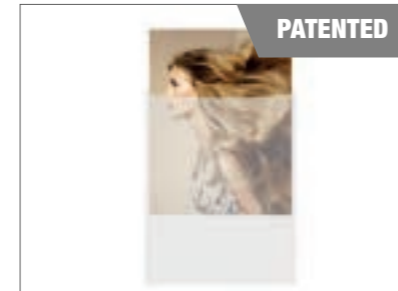

- IT**
 - Durata della locandina maggiore - busta in PVC resistente ai raggi UV
- ES**
 - Vida útil prolongada del póster: bolsa de PVC resistente a los rayos UV
- FR**
 - Prolongation de la durée de vie des affiches - enveloppe en PVC résistant aux UV

Art. nr. WRBAGA4
WRBAGA3
WRBAGA2
WRBAGA1
WRBAG50x70
WRBAG70x100

BROCHURE BASKET

Accessory for 25 mm Profile A-Board Design Standard, 32 mm Profile A-Board and Design Compasso® A-Board



- IT**
 - Finitura zincata per una lunga durata
- ES**
 - Acabado galvanizado para mayor durabilidad
- FR**
 - Finition galvanisée pour plus de durabilité

Art. nr. LHZPA4
LHZPA5

TOPCARD + WIREFRAME SET

Accessory for 32 mm Profile A-Board, DIN A1



- IT**
 - Espositore in PVC per applicazione di stampe o etichette in vinile
- ES**
 - Recuadro superior de PVC espumado adecuado para aplicaciones en carteles de vinilo o impresión
- FR**
 - Topcard en PVC adaptée à l'impression ou à l'application de signalisation en vinyle

Art. nr. TSZPA1

POSTER FOIL, FOIL SET

Accessory for A-Boards, Windtalker® and Snap Frames

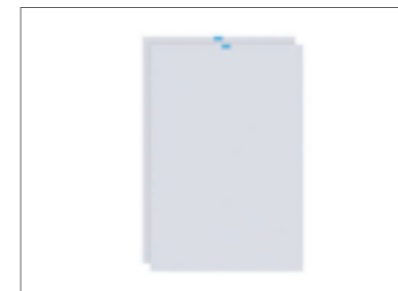

- IT**
 - Copertura locandina stabile ai raggi UV antiriflesso
- ES**
 - Folio protector antirreflejos y anti-UV
- FR**
 - Protection antireflet résistante aux UV pour les posters

Art. nr.	Foil	Foilset
	FOILA4*	SETFZPA4
	FOILA3*	SETFZPA3
	FOILA2*	SETFZPA2
	FOILA1*	SETFZPA1
	FOILA0*	SETFZPA0
	FOIL50x70*	SETFZP50x70
	FOIL70x100*	SETFZP70x100
	FOIL100x140*	SETFZP100x140

SET OF 2 BLACK WRITING FOILS AND 3 CHALK PENS

Accessory for A-Boards, Windtalker® and Snap Frames

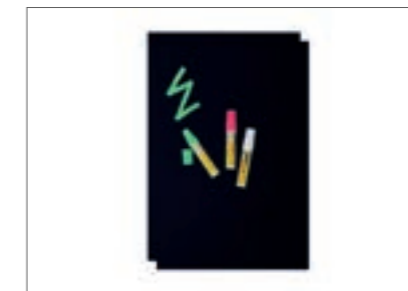

- IT**
 - Pennarelli a gesso rosa, bianco e verde
- ES**
 - Marcadores de tiza líquida en colores rosa, blanco y verde
- FR**
 - Feutres craie en rose, blanc et vert

Art. nr.	2 Black Foils + 3 pens	2 Black Foils
	SETZPA3	SETWFA3
	SETZPA2	SETWFA2
	SETZPA1	SETWFA1
	SETZPA0	SETWFA0
	SETZP50x70	SETWF50x70
	SETZP70x100	SETWF70x100

A-BOARD FABRIC MOVE

- IT**
 - Facile da spostare per la sua leggerezza e la borsa per il trasporto
 - Con facile attacco in velcro delle grafiche
 - Facile allestimento grazie a un assemblaggio che non necessita attrezzi
- ES**
 - Fácil movimiento gracias al peso ligero y una bolsa de transporte
 - Con una colocación de la gráfica fácil mediante velcro
 - Fácil montaje sin necesidad de usar herramientas
- FR**
 - Facile à déplacer grâce à sa légèreté et à son sac de transport
 - Avec fixation facile du visuel par Velcro
 - Installation facile grâce à un montage sans outil

PATENTED



Art. nr.	DIN/Size	Dimensions (cm)				KG
		W	H	D	KG	
ZPMA1	A1	69	105	74	2,7	
ZPM70x100	70 x 100	80	120	83	3,8	

- Included with a luxurious soft carry bag
- Same system as the well-known Zipper-Wall tube systems



CHALK A-BOARD SWING

- IT**
 - Cavalletto con lavagna in acciaio nero da esterno industriale ed elegante
 - Condividi i messaggi con un pennarello a gesso bianco
 - Perfetto per il mercato dell'accoglienza
- ES**
 - Caballete de pizarra para escribir con tiza, de acero negro, estilizada y con apariencia industrial para el uso en exteriores
 - Comparta el contenido escribiendo con un rotulador de tiza
 - Perfecto para el mercado de la hostelería
- FR**
 - Tableau noir d'extérieur en acier, élégant et industriel
 - Partager des messages avec un marqueur craie blanc
 - Parfait pour le marché de l'hôtellerie et de la restauration

Art. nr.	DIN/Size	Dimensions (cm)				KG
		W	H	D	KG	
ZPSW50x70	50 x 70	57,2	95,9	69,6	4,1	

- Included white chalkmarker



NEW



A-BOARD ELEGANT STEEL

- IT**
- Un design elegante e robusto in acciaio
 - Pannello di protezione anteriore con bordi per la facile sostituzione dei poster
 - Elegante finitura nera
- ES**
- Diseño de acero elegante y robusto
 - Plástico protector de carteles con cinta magnética para facilitar el intercambio de carteles
 - Revestido con un elegante acabado negro
- FR**
- Design élégant et robuste en acier
 - Film de protection des affiches avec bande magnétique pour changement facile des affiches
 - Revêtu d'une finition noire élégante



Art. nr.	DIN/Size	Dimensions (cm)			
		W	H	D	KG
ZPESA1BL	A1	67	104,5	71,5	12,3
ZPES50x70BL	50x70	57,5	96,5	64	9,7
ZPES70x100BL	70x100	77,5	116	85,5	15,3

• Included white chalkmarker



WINDTALKER® FABRIC

- IT**
 - Windtalker® con stampa del tessuto
 - Base in plastica da riempire con acqua (25 l) o sabbia (35 kg)
 - Molle in metallo spesse per vento forte
- ES**
 - Windtalker® con impresión de tela
 - Base de plástico para relleno de agua (25 l) o arena (35 kg)
 - Muelles metálicos y sólidos para aguantar el viento de alta velocidad
- FR**
 - Windtalker® avec visuel en tissu
 - Base en plastique pour remplissage d'eau (25 l) ou de sable (35 kg)
 - Ressorts métallique épais en cas de vent fort

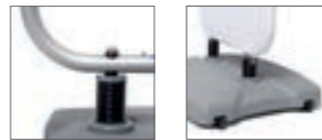

Art. nr.	DIN/Size	Dimensions (cm)			
		W	H	D	KG
WTRF70x100	70 x 100	70	125	59	7,8
WTRF70x200	70 x 200	70	225	59	8,8

WINDTALKER® PVC COVER

Accessory for Windtalker® City with Plastic Base

- IT**
 - Pubblica e cambia facilmente messaggi in breve tempo
 - Antispruzzo grazie al PVC
- ES**
 - Anuncie y cambie los mensajes temporales todavía más fácilmente
 - Resistente a las salpicaduras gracias al material de PVC
- FR**
 - Affichez et modifiez facilement des messages courts
 - À l'épreuve des éclaboussures grâce au PVC



Art. nr. COVERWTRA1	For Windtalker® City A1 (WTRA1)
COVERWTR70x100	For Windtalker® City 70 x 100 (WTR70x100)



BESTSELLER

WINDTALKER® CITY WITH PLASTIC BASE

- IT**
 - Grosse molle in metallo per grande resistenza al vento
 - Sistema di cornici a clip su 2 lati
 - Base in plastica da riempire con acqua o sabbia
- ES**
 - Muelles de acero gruesos para resistir al viento fuerte
 - Sistema de marco abatible en ambas caras
 - Base de plástico rellenable con agua o arena
- FR**
 - Ressorts métalliques épais en cas de vent fort
 - Système de cadre à pince sur 2 côtés
 - Base en plastique pour remplissage avec de l'eau ou du sable

Art. nr.	DIN/Size	☒	Dimensions (cm)			KG
			W	H	D	
WTRA1	A1	○	67	112,3	59	13,8
WTRA0	A0	○	88,7	149,7	83,5	23,6
WTR50x70	50 x 70	○	63,5	98,2	59	10,7
WTR70x100	70 x 100	○	83,5	130,8	83,5	19,4
WTRA1BLK	A1	●	67	112,3	59	13,8
WTRA0BLK	A0	●	88,7	149,7	88,7	23,6
WTR50x70BLK	50 x 70	●	63,5	98,2	63,5	10,7
WTR70x100BLK	70 x 100	●	83,5	130,8	83,5	19,4
Weatherproof (Splashproof)						
WTRA1WR	A1	○	67	112,3	59	13,8
WTR50x70WR	50 x 70	○	63,5	98,2	59	10,7
WTR70x100WR	70 x 100	○	83,5	130,8	83,5	19,4
WTRA1WRBLK	A1	●	67	112,3	59	13,8
WTR50x70WRBLK	50 x 70	●	63,5	98,2	59	10,7
WTR70x100WRBLK	70 x 100	●	83,5	130,8	83,5	19,4

- ☒ Topcard for A1 Windtalker® City and Leaflet Holder available on request
- ☒ Optional: Windtalker® PVC Cover (see p. 92)



WINDTALKER® EXCEL WITH PLASTIC BASE

- IT**
- Design di sicurezza con tappi di chiusura
 - Facile cambio di locandine
 - Molle rinforzate con pannello centrale a doppia parete a prova di calcio per una lunga durata
- ES**
- Diseño seguro con esquinas moldeadas y tapas
 - Fácil reemplazo de póster
 - Muelles reforzados con panel central resistente al impacto
- FR**
- Conception de sécurité avec embouts moulés
 - Changement facile de poster
 - Ressorts renforcés avec un panneau central double paroi résistant aux chocs pour plus de durabilité



Art. nr.	DIN/Size	Dimensions (cm)			
		W	H	D	KG
WTEA1	A1	62,5	121,5	50	17,5
WTEA0	A0	87,4	159,6	65	26,8
WTE70x100	70 x 100	81,2	140,7	65	23,9

WINDTALKER® EXCEL WITH METAL BASE

- IT**
- Gambe in acciaio sporgenti per una buona stabilità
 - Design di sicurezza privo di bordi taglienti
 - Chiusura Cornice a Scatto sui lati verticali che offre una maggiore protezione della locandina
- ES**
- Patas de metal salientes para gran estabilidad
 - Diseño seguro sin bordes afilados
 - Perfiles de presión verticales para mejor protección del póster
- FR**
- Pieds en acier en saillie pour une bonne stabilité
 - Conception de sécurité sans bords tranchants
 - Fermeture du cadre clic-clac sur les côtés verticaux pour une protection supplémentaire du poster

BACK TO OUR ASSORTMENT



Art. nr.	DIN/Size	Dimensions (cm)			
		W	H	D	KG
WTEE1	A1	62,4	1120	96	16,5
WTEE0	A0	87,1	146,8	130,5	20,1



6. LEAFLET AND CATALOGUE HOLDERS

Porta cataloghi e porta informazioni
Portafolletos y Catálogos
Porte-dépliants et Catalogues

Leaflet and Catalogue Holders will draw attention to your promotional literature. From flyers to brochures and leaflets, you can display any literature you want. Choose the one that suits you best: Catalogue racks, foldable brochure holders or rotating brochure stands. Ideal to use in a showroom, in the office, any point of sale or exhibitions and events.

INDEX

6.1 Leaflet and Catalogue Holders
Porta cataloghi e porta informazioni
Portafolletos y Catálogos
Porte-dépliants et Catalogues

98

- **MADE OF HIGH QUALITY ACRYLIC GLASS AND ALUMINIUM**
- **PERFECT FIT FOR DIFFERENT DIN SIZES**
- **GREAT SOLUTION FOR RETAIL AND OFFICES**

GOOD



BROCHURE HOLDER DESIGN STANDARD

- Lightweight and stable
- Clear styrene holder
- Option for customised logo panel

BETTER



BROCHURE RACK TOTEM

- Freestanding totem with brochure shelves
- Easy mounting
- Silver anodised aluminium profiles

BEST



SLIM CATALOGUE STAND

- Magnetic poster display for customised branding
- Attractive look with aesthetic design
- High capacity of A4 literature

BROCHURE STAND A4 ANGLED DESIGN STANDARD

- IT**
 - Base quadrata in legno con 4 piedini in gomma
 - Montante in alluminio anodizzato argento
 - Ripiano in metallo profondo 50 mm per materiale informativo in formato A4
- ES**
 - Base cuadrada de madera con cuatro patas de goma
 - Poste de aluminio anodizado en plata
 - Bandeja metálica con profundidad de 50 mm para material en formato DIN A4
- FR**
 - Base carrée en bois avec 4 pieds en caoutchouc
 - Pied en aluminium anodisé argent
 - Plateau en métal de 50 mm de profondeur pour les documents de format A4

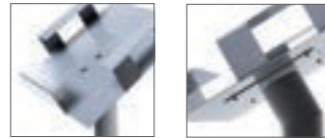

Art. nr.	DIN/Size	Dimensions (cm)			
		W	H	D	KG
MBD230	1 x A4	33	109,3	33	6,5

TRYS ROTATING - BROCHURE STAND

- IT**
 - Base girevole
 - Pronto all'uso - fornito completamente assemblato
 - 12 tasche in formato A4, 6 frontali e 6 posteriori
- ES**
 - Base giratoria
 - Listo para usar - suministrado completamente montado
 - 12 dispensadores, 6 frontales y 6 traseros
- FR**
 - Base rotative
 - Prêt à l'emploi - fourni entièrement assemblé
 - 12 pochettes A4, 6 à l'avant et 6 à l'arrière



Art. nr.	DIN/Size	Dimensions (cm)			
		W	H	D	KG
TRYS18	18 x A4	40	177	40	30,2
TRYS21	21 x A4	40	177	40	31,1
Modular elements	1 x A4				
TPOCKETA4		23,5	25	10,5	0,4

BROCHURE HOLDER DESIGN STANDARD

- IT**
 - Leggero e stabile
 - Contenitore in stirene trasparente
 - Possibilità di inserto con logo personalizzato
- ES**
 - Ligero y estable
 - Soporte de estireno transparente
 - Opción de panel con logotipo personalizado
- FR**
 - Léger et stable
 - Support en styrène transparent
 - Option pour panneau de logo personnalisé

BESTSELLER



Art. nr.	DIN/Size	Dimensions (cm)			
		W	H	D	KG
MB3C160	3 x A5	33	106	33	4,8
MB3C230	3 x A4	33	116,5	33	5,2
MB4C110	4 x DL	33	106	33	2,6
MB4C160	4 x A5	33	106	33	4,8
MB4C230	4 x A4	33	111,5	33	5,3
MB4C330	5 x A4	33	111,5	33	4,9

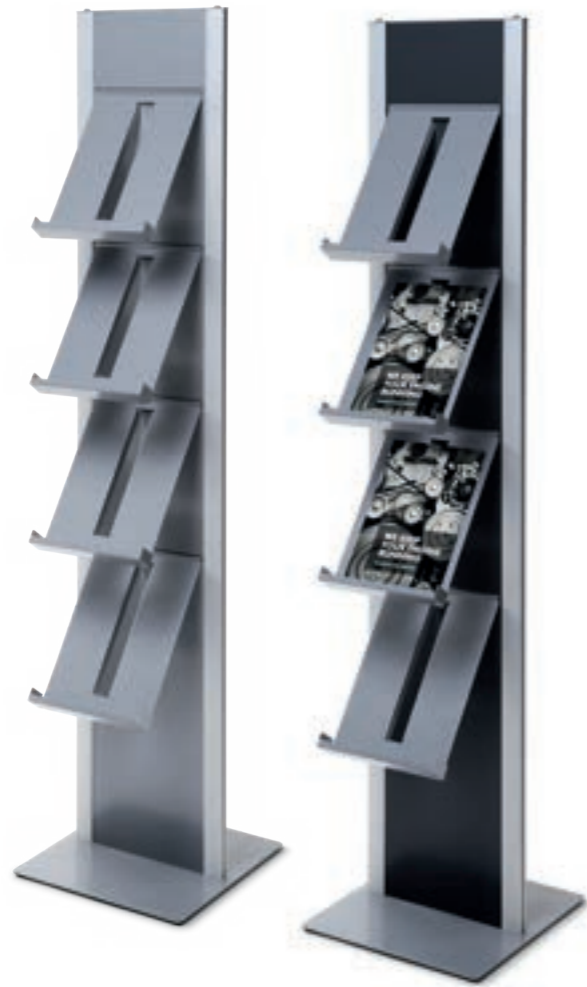

BESTSELLER

BROCHURE RACK TOTEM

- IT**
- Totem da pavimento con ripiani per brochure
 - Facile da montare
 - Profili argentati in alluminio anodizzato
- ES**
- Tótem de pie con estantes para catálogos
 - Montaje fácil
 - Bordes de aluminio anodizado en plata
- FR**
- Totem sur pied avec étagères pour brochures
 - Montage facile
 - Profils en aluminium anodisé argent



Art. nr.	DIN/Size	Dimensions (cm)			
		W	H	D	KG
Rack with pockets set					
BRT4S	A4	37	167,4	41,7	13,8
BRTBL4S	A4	41,7	167,4	37	13,7
Modular elements					
BRT	-	37	166,5	41,7	12
BRSx2	A4	24,6	34	5,8	1,4
TPOCKETA4x2	A4	23,5	25	10,5	0,9



SLIM CATALOGUE STAND

- IT**
 - Espositore pubblicitario magnetico per marchi personalizzati
 - Aspetto accattivante con design estetico
 - Può contenere grandi quantità di materiale informativo in formato A4
- ES**
 - Expositor magnético para personalizar su branding
 - Look atractivo con diseño estético
 - Alta capacidad de folletos DIN A4
- FR**
 - Poster magnétique pour un branding personnalisé
 - Look attrayant avec un design esthétique
 - Capacité élevée de documents A4



Art. nr.	DIN/Size	Dimensions (cm)			
		W	H	D	KG
CSA4C9005	A4	27	115,2	30,1	10,2

Other colours available on request

LEAFLET STAND WITH MAGNETIC POCKET

- IT**
 - Tasca magnetica per comodità dell'utilizzatore
 - Design elegante per un'estetica eccezionale
 - Struttura stabile e affidabile
- ES**
 - Marco magnético para la comodidad del usuario
 - Diseño elegante para mejor estética
 - Estable y de estructura sólida
- FR**
 - Pochette magnétique pour plus de commodité
 - Conception intelligente pour une esthétique exceptionnelle
 - Structure stable et fiable



Art. nr.	DIN/Size	Dimensions (cm)			
		W	H	D	KG
MBMA4PC9005	A4	21,8	115,2	21,8	7,3

Other colours available on request

ZIG ZAG BROCHURE STAND STANDARD

- IT**
 - Montante laterale in alluminio con base in legno MFC laminata argento con 4 piedini in gomma
 - Facile e veloce da assemblare
 - 6 ripiani per brochure in argento verniciate a polvere (RAL 9006) per materiale pubblicitario in formato A4 verticale
- ES**
 - Perfil de aluminio y 4 pies de goma
 - Montaje fácil y rápido
 - 6 estanterías con revestimiento de polvo plateado (RAL 9006) aptas para A4
- FR**
 - Cadre en aluminium, équipé de 4 pieds en caoutchouc
 - Rapide et facile à assembler
 - 6 étagères acier thermolaqué argent (RAL 9006) pour documents au format A4 portrait



Art. nr.	DIN/Size	Dimensions (cm)			KG
		W	H	D	
ZZPUA	A4	30	152	45	8,3



ZIG ZAG BROCHURE STAND FOLDABLE

- IT**
- Struttura in alluminio dotata di 4 piedini in gomma
 - Facile e veloce da assemblare
 - Lussuosa e solida custodia da trasporto con serratura e protezione interna in schiuma
- ES**
- Perfil de aluminio y 4 pies de goma
 - Fácil de montar
 - Incluye funda sólida con una capa de espuma interior para mayor pro
- FR**
- Cadre en aluminium, équipé de 4 pieds en caoutchouc
 - Facile à installer
 - Comprend un boîtier solide avec mousse et protection à l'intérieur

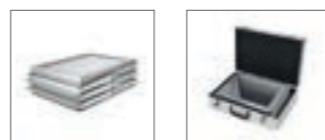

Art. nr.	DIN/Size	Dimensions (cm)			
		W	H	D	KG
BHZZA	A4	28	143	35	8,4

BROCHURE HOLDER DELUXE

- IT**
- Portadepliant estremamente stabile che occupa uno spazio minimo
 - Contenitori in acrilico trasparente
 - Borsa imbottita rinforzata con cerniera
- ES**
- Muy estable y con una ocupación de espacio mínima
 - Acrílicos transparentes
 - Bolsa de transporte acolchada con cremallera
- FR**
- Porte-brochures extrêmement stable qui occupe un espace minimal
 - Porte-brochures en acrylique transparent
 - Sac rembourré renforcé avec fermeture à glissière



Art. nr.	DIN/Size	Dimensions (cm)			
		W	H	D	KG
BHL	A4	24	156	29	6,8



HOSPITALITY

Hospitality
Hostelería
Hospitalité



Make sure your menu or information pops out thanks to the various hospitality displays. Suitable for restaurants, hotels, cafes or other hospitality establishments. Stay authentic and optimise your promotion with our various designs, materials and sizes.

DIGITAL WALL PANEL
See 4. Digital Displays
page 73



CAFE BARRIER ECONOMY
See 12. Wayfinding Systems
page 182



NEW

WOODEN A-BOARD ECONOMY
See 7. Wooden Signs
page 111



NEW

WOODEN A-BOARD FLIP
See 7. Wooden Signs
page 110



CHALK A-BOARD SWING
See 5. Pavement Signs
page 89



WOODEN CHALK BOARDS
See 7. Wooden Signs
page 115



OUTDOOR MENU FRAME STAND BLACK
See 8. Menu Displays
page 124



BICYCLE STAND
See 9. Outdoor Equipment
page 142



WOODEN SHOWCASE
See 8. Menu Displays
page 128



also in
double-sided
graphic

NEW

BEACH FLAG ALU PADDLE
See 16. Flags
page 238



LOCKABLE MENU STAND LOGO / LED
See 8. Menu Displays
page 127



OUTDOOR MENU CASE LOGO / LED
See 8. Menu Displays
page 129



A-BOARD ELEGANT STEEL
See 5. Pavement Signs
page 90



ALUMINIUM A-BOARDS
See 5. Pavement Signs
page 84

NEW

PLACEMATS
See 8. Menu Displays
page 138



interesting categories for you

1. POSTER FRAMES AND DISPLAYS	10
2. TEXTILE FRAMES	36
4. DIGITAL DISPLAYS	62
5. PAVEMENT SIGNS	82
7. WOODEN SIGNS	108
8. MENU DISPLAYS	122
9. OUTDOOR EQUIPMENT	140
11. FLIPCHARTS AND WRITABLE BOARDS	164
12. WAYFINDING SYSTEMS	176
15. BANNERS	202
16. FLAGS	230

7. WOODEN SIGNS

Espositori in legno
Carteles en Madera
Panneaux en Bois

Wooden Signs offer an authentic, antique and vintage look. A-Boards, chalkboards and table top displays are made from durable hardwood or MDF. Easy to clean and allow you to quickly change your message. Ideal for restaurants, bars, cafes and other hospitality establishments.

- HIGH QUALITY STAINED (HARD)WOOD OR MDF PROFILE
- SUITABLE FOR CHALKMARKERS AND EASY TO CLEAN
- DIFFERENT WOODEN DESIGNS TO MATCH DIFFERENT INTERIORS WITH INDIVIDUAL BRANDING OPTIONS

INDEX

- | | |
|--|------------|
| 7.1 Wooden Chalk A-Boards
<i>Cavalletti in legno con lavagna</i>
<i>Caballetes de Madera</i>
<i>Stop-trottoirs en Bois pour Craie</i> | 110 |
| 7.2 Wooden Chalk Boards
<i>Cavalletti in legno con lavagna</i>
<i>Pizarras de Madera</i>
<i>Tableaux en Bois pour Craie</i> | 115 |
| 7.3 Wooden Table Tops
<i>Porta informazioni da tavolo in legno</i>
<i>Pizarra de Sobremesa</i>
<i>Dessus de Table en Bois</i> | 119 |



✓ GOOD NATURA CHALK A-BOARD CLASSIC

- Lightweight wood
- Economy version A-Board
- Stained wood with matt varnish protection



👍 BETTER NATURA CHALK FAST-SWITCH A-BOARD

- Hardwood A-Board for stylish atmosphere
- Rounded top look
- Effortless chalk panel switch



🏆 BEST NATURA CHALK A-BOARD ANTIQUE

- Rustic vintage look
- 40 mm hardwood frame with chalk board
- Matt varnish protection

NEW



WOODEN A-BOARD FLIP

- IT**
- Lavagna a cavalletto unica & bifacciale
 - Lavagna elegante di aspetto rustico in legno di faggio
 - Adatta per esterni al coperto
- ES**
- Con un giro de tablero es posible escribir mensajes en ambos lados
 - Pizarra rústica de madera de haya
 - Apto para uso en exteriores bajo techo
- FR**
- Basculement unique du panneau pour les messages sur les deux faces
 - Charmant tableau rustique en bois de hêtre
 - Convient aux espaces extérieurs couverts

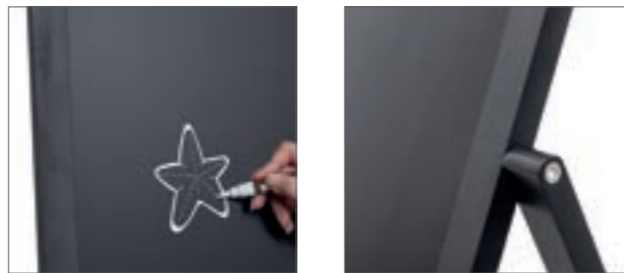

Art. nr.	DIN/Size	🌀	Dimensions (cm)			
			W	H	D	KG
ZPCHFLB68x140	62 x 114	●	68	134	64	5,7
ZPCHFLB55x105	49 x 89	●	55	100,5	53	3,9
ZPCHFBL68x140	62 x 114	●	68	134	64	5,7
ZPCHFBL55x105	49 x 89	●	55	100,5	53	3,9

🌀 Optional: Brand with your logo



WOODEN A-BOARD ECONOMY

NEW

- IT**
- Facile da richiudere e trasportare
 - Leggera ma robusta
 - Adatta per esterni al coperto
- ES**
- Fácil de plegar y transportar
 - Ligera pero robusta
 - Adecuada para exteriores cubiertos
- FR**
- Facile à plier et à transporter
 - Léger, mais robuste
 - Convient aux espaces extérieurs couverts



Art. nr.	DIN/Size	🌀	Dimensions (cm)			
			W	H	D	KG
ZPCHFLB51x65	51 x 65	●	55	82	51,5	4,8

- 🌀 Optional: Brand with your logo
- 📌 As this is a natural product, the colours can slightly differ



NATURA CHALK A-BOARD

- IT**
- Adatti per aree interne ed esterne coperte
 - Profilo piatto in legno di alta qualità
 - Cerniere in acciaio zincato
- ES**
- Uso tanto interior como en exterior cubierto
 - Perfil de madera plana de alta calidad
 - Bisagras de acero galvanizado
- FR**
- Convient aux zones intérieures et extérieures couvertes
 - Profil en bois dur plat de haute qualité
 - Charnières en acier galvanisé



Art. nr.	DIN/Size	☒	Dimensions (cm)			
			W	H	D	KG
ZPCHBLB55x85	55 x 85	●	55	81,5	56,7	7,7
ZPCHBLB68x120	68 x 120	●	68	114,8	78,4	13,2
ZPCHBBR55x85	55 x 85	●	55	81,5	58,6	7,7
ZPCHBBR68x120	68 x 120	●	68	114,8	80,3	13,2
ZPCHBBL55x85	55 x 85	●	55	81,5	56,7	7,7
ZPCHBBL68x120	68 x 120	●	68	114,8	78,4	13,2



- ☒ Optional: Brand with your logo
- ⓘ As this is a natural product, the colours can slightly differ



NATURA CHALK A-BOARD CLASSIC

- IT**
- Legno leggero
 - Lavagna a cavalletto economica
 - Legno pitturato e protetto con vernice opaca
- ES**
- Madera ligera
 - Versión económica de pizarras de caballete
 - Madera tratada con barniz protector mate
- FR**
- Bois léger
 - Stop-trottoir économique
 - Bois teinté avec protection vernie mate



Art. nr.	DIN/Size	☒	Dimensions (cm)			
			W	H	D	KG
ZPCHBELB55x85	55 x 85	●	55	82,5	50	4
ZPCHBEBR55x85	55 x 85	●	55	82,5	50	4
ZPCHBEBL55x85	55 x 85	●	55	82,5	50	4



- ☒ Optional: Brand with your logo
- ⓘ As this is a natural product, the colours can slightly differ



NATURA CHALK FAST-SWITCH A-BOARD

- IT**
- Cavalletto in legno per un'atmosfera elegante
 - Parte superiore arrotondata
 - Cambio lavagna senza sforzo
- ES**
- Pizarra de Caballete Fast Switch de madera noble para crear un ambiente con estilo
 - Aspecto redondeado de la parte superior
 - Cambio de panel de escritura sin esfuerzo
- FR**
- Stop-trottoir en bois dur pour une atmosphère élégante
 - Partie supérieure arrondie
 - Changement facile de tableau noir

Art. nr.	DIN/Size	☒	Dimensions (cm)			
			W	H	D	KG
ZPCHBFSLB55x85	55 x 85	●	55	86,2	58,6	6,5
ZPCHBFSLB68x120	68 x 120	●	68	119,7	80,2	10,4

- ☒ Optional: Brand with your logo





NATURA CHALK A-BBOARD ANTIQUE

- IT**
- Aspetto vintage e rustico
 - Cornice in legno da 40 mm con lavagna
 - Protezione con vernice opaca
- ES**
- Estilo vintage y rústico
 - Perfil de madera noble de 40 mm con pizarra de tiza
 - Barniz protector mate
- FR**
- Look rustique vintage
 - Cadre en bois dur de 40 mm avec tableau noir
 - Protection vernie mate

Art. nr.	DIN/Size	Dimensions (cm)				KG
		W	H	D		
ZPCHBLX59x116	59 x 116	59	107	103,2	13	

Optional: Brand with your logo



NATURA CHALK BOARD ECONOMY

- IT**
- Lavagna pratica ed economica
 - Perfetta per promozioni nei bar e nei ristoranti
 - Cornice in MDF con effetto legno
- ES**
- Pizarra de tiza práctica y económica
 - Opción perfecta para promociones de hoteles, bares y restaurantes
 - Marco de madera prensada DM con aspecto de madera
- FR**
- Tableau noir pratique et peu coûteux
 - Parfait pour les promotions dans les cafés, bars ou restaurants
 - Cadre en MDF avec aspect bois

Art. nr.	DIN/Size		Dimensions (cm)			
			W	H	D	KG
CHBFBL50x60	50 x 60	●	50	60	1,2	1,9
CHBFBL60x80	60 x 80	●	60	80	1,2	3
CHBFBL70x90	70 x 90	●	70	90	1,2	3,9

Optional: Brand with your logo



BESTSELLER



NATURA CHALK BOARD CLASSIC

- IT**
- Aspetto vintage e antico
 - Facile pulizia a secco
 - Legno pitturato e protetto con vernice opaca
- ES**
- Estilo vintage y rústico
 - Borrado en seco
 - Madera tratada con barniz protector mate
- FR**
- Aspect ancien
 - Nettoyage facile à sec
 - Bois teinté avec protection vernie mate

Art. nr.	DIN/Size		Dimensions (cm)			
			W	H	D	KG
CHBELB50x60	50 x 60	●	50	60	2	7,3
CHBELB60x80	60 x 80	●	60	80	2	8
CHBELB70x90	70 x 90	●	70	90	2	9
CHBEBR50x60	50 x 60	●	50	60	2	7,3
CHBEBR60x80	60 x 80	●	60	80	2	8
CHBEBR70x90	70 x 90	●	70	90	2	9
CHBEBL50x60	50 x 60	●	50	60	2	7,3
CHBEBL60x80	60 x 80	●	60	80	2	8
CHBEBL70x90	70 x 90	●	70	90	2	9

Optional: Brand with your logo

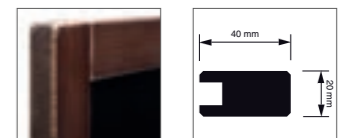

BESTSELLER

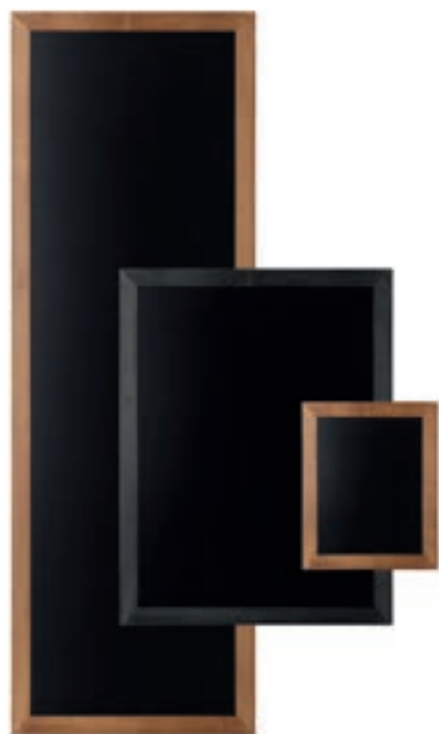

NATURA CHALK BOARD

- IT**
- Profili piatti in legno di alta qualità
 - Pannelli truciolari nobilitati in MFC
 - Disponibile in un'ampia gamma di formati
- ES**
- Perfil plano de madera noble de alta calidad
 - Paneles de aglomerado de melamina MFC
 - Disponible en una amplia gama de tamaños
- FR**
- Profils plats en bois dur de haute qualité
 - Panneaux agglomérés à face mélaminée MFC
 - Disponibles dans une large gamme de dimensions

Art. nr.	DIN/Size		Dimensions (cm)			
			W	H	D	KG
CHBLB30x40	30 x 40	●	30	40	2	1,4
CHBLB40x50	40 x 50	●	40	50	2	2,1
CHBLB50x60	50 x 60	●	50	60	2	2,9
CHBLB60x80	60 x 80	●	60	80	2	5,3
CHBLB70x90	70 x 90	●	70	90	2	6,8
CHBLB40x120	40 x 120	●	40	120	2	5,4
CHBLB56x100	56 x 100	●	56	100	2	6,1
CHBLB56x120	56 x 120	●	56	120	2	7,2
CHBLB56x150	56 x 150	●	56	150	2	7,3
CHBLB56x170	56 x 170	●	56	170	2	8,2
CHBBL30x40	30 x 40	●	30	40	3	1,3
CHBBL40x50	40 x 50	●	40	50	3	2
CHBBL50x60	50 x 60	●	50	60	3	2,8
CHBBL60x80	60 x 80	●	60	80	3	5,3
CHBBL70x90	70 x 90	●	70	90	3	6,8
CHBBL40x120	40 x 120	●	40	120	3	4,4
CHBBL56x100	56 x 100	●	56	100	3	6,1
CHBBL56x120	56 x 120	●	56	120	3	5,9
CHBBL56x150	56 x 150	●	56	150	3	8,9
CHBBL56x170	56 x 170	●	56	170	3	8,2

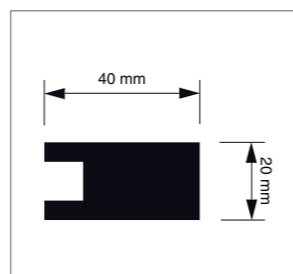

- Optional: Brand with your logo
- As this is a natural product, the colours can slightly differ

NATURA EASEL

- IT**
- Supporto per dare maggiore esposizione alle lavagne
 - Disponibile in due colori
 - Legno tinto con protezione con vernice opaca
- ES**
- Soporte para darle mejor visibilidad a la pizarra
 - Disponible en 2 colores
 - Madera noble tratada con barniz protector mate
- FR**
- Support donnant une visibilité supplémentaire aux tableaux noirs
 - Disponible en 2 couleurs
 - Bois dur coloré avec protection vernie mate

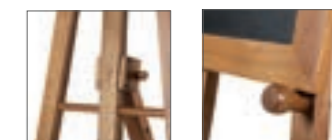

Art. nr.		Dimensions (cm)			
		W	H	D	KG
CHBLBEASEL	●	85	161	76	3,6
CHBBLEASEL	●	85	161	76	3,6



NEW

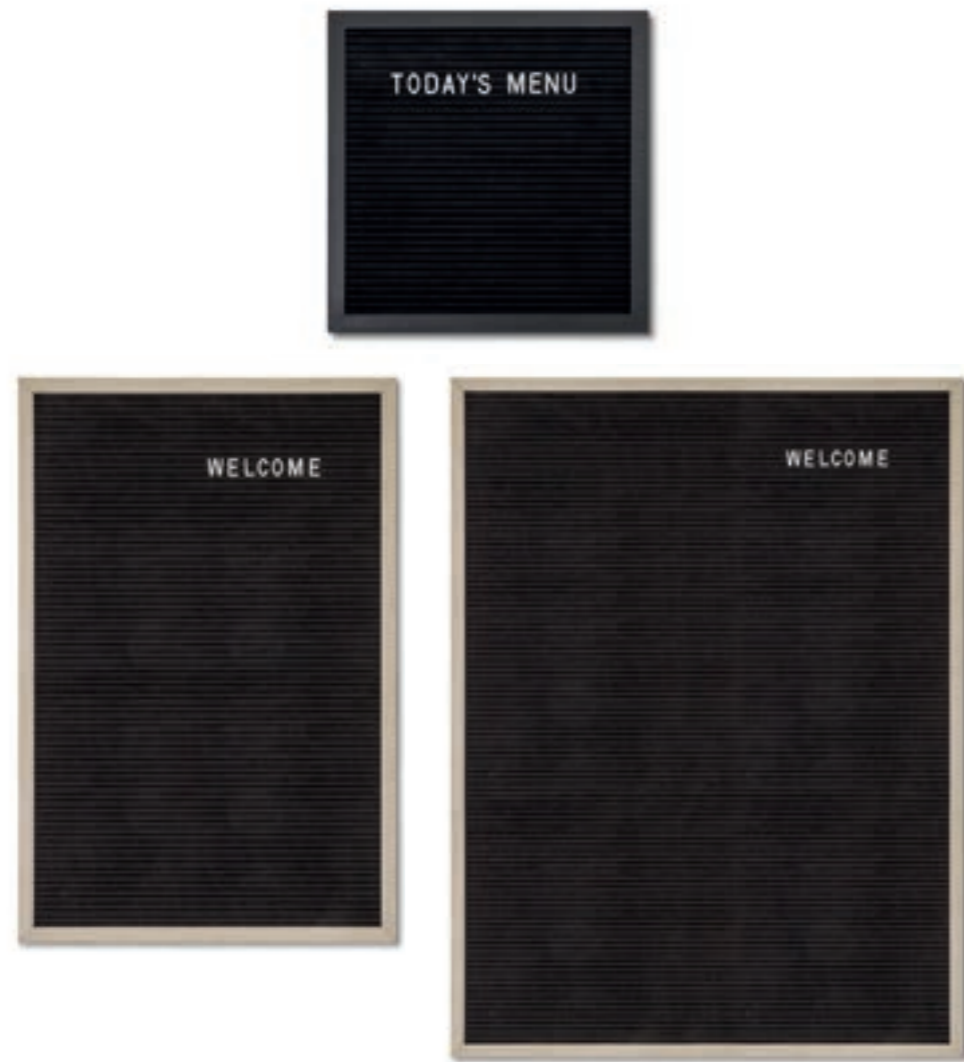

BLACK LETTER BOARD

- IT**
- Cornice design vintage ed elegante
 - 330 lettere e 120 numeri compresi
 - Ideale per l'ospitalità e l'ufficio
- ES**
- Diseño de marco vintage y estilizado
 - 500 piezas de letras incluidas
 - Perfecto para la hostelería y las oficinas
- FR**
- Cadre au design vintage et élégant
 - 500 lettres sont incluses
 - Parfait pour le secteur de l'hospitalité et les bureaux



Art. nr.	DIN/Size	Dimensions (cm)			KG
		W	H	D	
LEB30x30	30 x 30	30	30	1,9	0,6
LEB40x60	40 x 60	40	60	1,9	1,5
LEB60x80	60 x 80	60	80	1,9	2,6
LEBBL30x30	30 x 30	30	30	1,9	0,6
LEBBL40x60	40 x 60	40	60	1,9	1,5
LEBBL60x80	60 x 80	60	80	1,9	2,6

① Sizes 30 x 30 cm and 40 x 60 cm are suitable for both wall hanging or counter use
Size of 60 x 80 cm is suitable for wall hanging only



NEW

WOODEN T STAND MENU HOLDER

- IT**
- Durevole legno di quercia
 - Facile da pulire
 - Si cambia il contenuto in un attimo
- ES**
- Madera de roble resistente
 - Fácil de limpiar
 - Cambia de contenido en un segundo
- FR**
- Bois de chêne durable
 - Facile à nettoyer
 - Changez de contenu en une fraction de seconde



Art. nr.	DIN/Size	Dimensions (cm)			KG
		W	H	D	
TA4PW	A4	21	32,5	6	0,5
TA5PW	A5	15	23,7	5	0,3
TA6PW	A6	10,5	17,7	4	0,2



NATURA TABLE TOP CHALK BOARD

BESTSELLER

- IT**
 - Ideale per presentazioni speciali
 - Supporto in legno tinto
 - Scrittura e pulizia facili da eseguire
- ES**
 - Ideal für besondere Angebote
 - Gebeizter Hartholzfuß
 - Einfaches Schreiben und Reinigung
- FR**
 - Idéal pour wisselende promoties
 - Gebeitst hardhouten voet
 - Eenvoudig te beschrijven en schoon te maken



Art. nr.	DIN/Size	✕	Dimensions (cm)			KG
			W	H	D	
TCHBLBA4	A4	●	26	31,7	6	0,8
TCHBLBA5	A5	●	20	23	6	0,5
TCHBBRA4	A4	●	26	31,7	6	0,8
TCHBBRA5	A5	●	20	23	6	0,5
TCHBBLA4	A4	●	26	31,7	6	0,8
TCHBBLA5	A5	●	20	23	6	0,5

Optional: Brand with your logo

SET OF WHITE PLASTIC LETTERS

Accessory for Black Letter Board



NEW

- IT** • Due fogli di 150 lettere
- ES** • 2 Blätter mit 150 Buchstaben
- FR** • 2 vellen van 150 letters

Art. nr. LEB-LHEAD

CHALK MARKERS 3 MM

Accessory for all Chalk Boards and A-Boards



- IT** • Facili da pulire
- ES** • Leicht zu reinigen
- FR** • Makkelijk schoon te maken

- Art. nr.
- CHMARK3WHITE
 - CHMARK3YELLOW
 - CHMARK3RED
 - CHMARK3DARKGREEN
 - CHMARK3DARKBLUE

CHALK MARKERS 15 MM

Accessory for all Chalk Boards and A-Boards



- IT** • Facili da pulire
- ES** • Leicht zu reinigen
- FR** • Makkelijk schoon te maken

- Art. nr.
- CHMARK15WHITE
 - CHMARK15YELLOW
 - CHMARK15RED
 - CHMARK15DARKGREEN
 - CHMARK15DARKBLUE

Natura Chalk Board (p. 116/ch. 7), Black Outdoor Menu / LED (p. 129/ch.8)

BLACK PRICE L-STAND

- IT**
 - Ideale per esporre le offerte del giorno
 - Leggera e stabile
 - Design classico
- ES**
 - Ideal für tägliche Angebote
 - Leicht und stabil
 - Klassisches Design
- FR**
 - Idéal pour présentation van dagaanbiedingen
 - Lichtgewicht en stabiel
 - Klassiek ontwerp

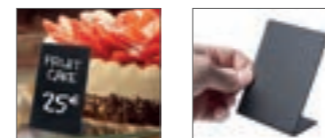

Art. nr.	DIN/Size	Dimensions (cm)			
		W	H	D	KG
LA7PBL	A7	7,4	10,5	4,5	0,03
LA6PBL	A6	10,5	14,6	6	0,05
LA5PBL	A5	14,8	20,4	7,5	0,09

120 See accessory page for options (p. 121)



NAVARRA

8. MENU DISPLAYS

Porta Menu
Porta Menú
Affichages de Menu

Ideal for displaying restaurant menus and other promotional messages. Content can be changed easily. Commonly used in the hospitality sector. Products include freestanding stands, wall mounted menu boards and table top displays. Available in different sizes and colours. Optional LED lighting available.

INDEX

8.1 Menu Displays **124**
Espositori per menu
Porta Menú
Affichages de Menu

8.2 Menu Table Tops **134**
Portamenù da tavolo
Porta Menú de Mesa
Présentoirs de Menus pour Tables

- **STURDY ALUMINIUM DESIGNS WITH AND WITHOUT LED OPTIONS**
- **PERFECT FIT FOR DIFFERENT DIN SIZES**
- **GREAT SOLUTION FOR HOSPITALITY**



GOOD

**LOCKABLE MENU STAND
LOGO / LED**

- Functional anodised info pole
- Top card for individual logos
- Suitable for outdoor use in covered area



BETTER

**BLACK FREESTANDING MENU POLE
/ LED**

- Lockable header
- With or without LED strips
- Indoor or covered outdoor use



BEST

**OUTDOOR MENU BOARD PREMIUM
/ LED**

- Unique premium design
- Special extra stable angular pole
- Safety glass with black ceramic graphic



OUTDOOR MENU FRAME STAND BLACK

- IT**
- Portamenù da esterno, autoportante, in un moderno colore nero
 - Design di alto livello a un prezzo conveniente
 - Con chiusura a chiave
- ES**
- Un portamenú de pie en color negro y moderno para uso en exteriores
 - Diseño premium con un precio asequible
 - Se cierra con llave
- FR**
- Présentoir de menu pour l'extérieur, autoportant, de couleur noire moderne
 - Une conception de qualité supérieure à un prix abordable
 - Verrouillable par clé



Art. nr.	DIN/Size	Dimensions (cm)			
		W	H	D	KG
SCPF8xA4C9005	8 x A4	59,8	166	44,8	14,6

With wheels for easy mobility



BLACK FREESTANDING MENU POLE / LED

- IT**
 - Espositore con serratura
 - Con o senza strisce LED
 - Uso interno o esterno coperto
- ES**
 - Cabecera con cierre
 - Con o sin tiras LED
 - Para interiores y zonas exteriores cubiertas
- FR**
 - Embase verrouillable
 - Avec ou sans bandes de LED
 - Utilisation intérieure ou extérieure couverte



Art. nr.	DIN/Size	Dimensions (cm)			
		W	H	D	KG
Non-illuminated					
SCZNPOL4x4A4C9005	4 x A4	50	128	40	15,5
Illuminated					
SCZNPOL4x4A4C9005LED	4 x A4	50	128	40	15,7

ⓘ Electrical connection must be indoor or via IP rated electrical box

BLACK LOCKABLE MENU STAND / LED

- IT**
 - Design minimalista ed elegante
 - Vetrina in alluminio con serratura sul bordo superiore
 - Piastra a terra in acciaio pesante
- ES**
 - Diseño minimalista y elegante
 - Vitrina de aluminio con cerradura
 - Base de acero sólida
- FR**
 - Conception minimaliste élégante
 - Vitrine en aluminium, verrouillable sur le dessus
 - Plaque de sol en acier lourd



Art. nr.	DIN/Size	Dimensions (cm)			
		W	H	D	KG
Non-illuminated					
MBSCZN2xA4C9005	2 x A4	50,5	112,5	45	10
Illuminated					
MBSCZN2xA4C9005LED	2 x A4	50,5	112,5	45	10,5

ⓘ Electrical connection must be indoor or via IP rated electrical box

FREESTANDING MENU POLE LOGO / LED

- IT**
 - Design a doppio montante con un'ampia base in acciaio
 - Pannello logo per marchio
 - Pannello frontale in policarbonato con serratura
- ES**
 - Diseño de dos postes en una base amplia de acero
 - Panel para su logo y branding
 - Vitrina con cerradura y panel frontal de policarbonato
- FR**
 - Conception à deux montants avec grande base en acier
 - Panneau logo pour la marque
 - Panneau avant verrouillable en polycarbonate



Art. nr.	DIN/Size	Dimensions (cm)			
		W	H	D	KG
Non-illuminated					
SCZPOLE4xA4	4 x A4	50,5	163	40	14,5
Illuminated					
SCZPOLE4xA4LED	4 x A4	50,5	163	40	14,8

ⓘ Electrical connection must be indoor or via IP rated electrical box

LOCKABLE MENU STAND LOGO / LED

- IT**
 - Palo informativo anodizzato funzionale
 - Espositore per loghi personalizzati
 - Adatto a un utilizzo esterno in aree coperte
- ES**
 - Poste funcional anodizado
 - Espacio para logotipo
 - Adecuado para uso en exterior cubierto
- FR**
 - Tringle d'information fonctionnelle anodisée
 - Carte supérieure pour logos individuels
 - Équipé pour une utilisation en extérieur dans une zone couverte



Art. nr.	☒	DIN/Size	Dimensions (cm)			
			W	H	D	KG
Non-illuminated						
MBSCZ1xA4	●	1 x A4	45	115	45	9,1
MBSCZ2xA4	●	2 x A4	50,5	115	45	10,7
MBSCZ2xA4C9005	●	2 x A4	50,5	115	45	9,5
Illuminated						
MBSCZ2XA4LED	●	2 x A4	50,5	115	45	12,1

ⓘ Electrical connection must be indoor or via IP rated electrical box



WOODEN SHOWCASE

- IT**
- Bacheca elegante con cornice in legno
 - Fondo nero magnetico pulibile a secco
 - Perno di chiusura facile e vintage
- ES**
- Tablón de anuncios moderno con marco de madera
 - Trasera magnética negra de borrado en seco
 - Cierre fácil de estilo vintage
- FR**
- Élégant tableau d'affichage avec cadre en bois
 - Paroi arrière magnétique noire effaçable à sec
 - Fermeture facile et vintage

Art. nr.	DIN/Size	Dimensions (cm)			
		W	H	D	KG
SCWA3	A3	30	42	3,7	1,9

- Perfect for hospitality and office
 - Use chalkmarkers and magnet to write and hang your content.
- See p. 121/ch. 7, p. 162/ch. 10 and p. 174/ch. 11

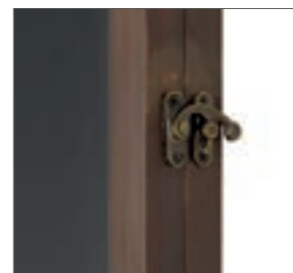

BLACK OUTDOOR MENU CASE / LED

- IT**
- Vetrina nera per montaggio a parete
 - Stabile struttura in alluminio con serratura
 - Pannello frontale in policarbonato
- ES**
- Vitrina negra para montaje en la pared
 - Construcción de aluminio estable con cerradura
 - Panel frontal de policarbonato
- FR**
- Vitrine noire pour montage mural
 - Structure stable en aluminium verrouillable
 - Panneau avant en polycarbonate

Art. nr.	DIN/Size	Dimensions (cm)			
		W	H	D	KG
Non-illuminated					
SCZN2xA4C9005	2 x A4	50,5	37,7	2,2	2,4
SCZN4xA4C9005	4 x A4	50,5	67,9	2,2	3,7
Illuminated					
SCZN2xA4C9005LED	2 x A4	50,5	37,7	2,2	2,7
SCZN4xA4C9005LED	4 x A4	50,5	67,9	2,2	4

- Electrical connection must be indoor or via IP rated electrical box



OUTDOOR MENU CASE LOGO / LED

- IT**
- Profilo in alluminio anodizzato da 37 mm
 - Perfetta davanti ai ristoranti e ai bar
 - Pannello logo per marchio personalizzato
- ES**
- Perfil de aluminio anodizado de 37 mm
 - Perfecto para la entrada de los restaurantes, bares y cafeterías
 - Panel para su logo
- FR**
- Profil en aluminium anodisé de 37 mm
 - Parfait devant les restaurants, les bars et les cafés
 - Panneau avec logo pour le marquage individuel

Art. nr.	DIN/Size	Dimensions (cm)			
		W	H	D	KG
Non-illuminated					
SCZ1XA4	1 x A4	29	47,7	2,3	2,5
SCZ2XA4	2 x A4	50,5	47,7	2,3	3,8
SCZ2XA4T	2 x A4	29	77,9	2,3	3,7
SCZ4XA4	4 x A4	50,5	77,9	2,3	5,6
SCZ1xA4C9005	1 x A4	29	47,7	2,3	2,2
SCZ2xA4C9005	2 x A4	50,5	47,7	2,3	3,3
SCZ4xA4C9005	4 x A4	50,5	77,9	2,3	5
Illuminated					
SCZ1XA4LED	1 x A4	29	47,7	2,3	2,8
SCZ2XA4LED	2 x A4	50,5	47,7	2,3	4,1
SCZ2XA4TLED	2 x A4	29	77,9	2,3	4
SCZ4XA4LED	4 x A4	50,5	77,9	2,3	5,9
SCZ1xA4LEDC9005	1 x A4	29	47,7	2,3	2,5
SCZ2xA4LEDC9005	2 x A4	50,5	47,7	2,3	3,7
SCZ4xA4LEDC9005	4 x A4	50,5	77,9	2,3	5,3

- Electrical connection must be indoor or via IP rated electrical box

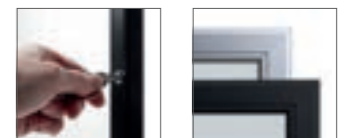

OUTDOOR MENU BOARD PREMIUM

- IT**
- Design premium unico
 - Palo angolare super stabile speciale
 - Vetro di sicurezza con grafica in ceramica nera
- ES**
- Diseño Premium especial
 - Poste angular especial extra estable
 - Cristal templado con impresión cerámica negra
- FR**
- Conception haut de gamme unique
 - Poteau angulaire spécial ultra-stable
 - Verre de sécurité avec imprimé en céramique noire



Art. nr.	DIN/Size	Dimensions (cm)			
		W	H	D	KG
MBSCEOSA2LED	A2	73,7	138,4	58	32,1
MBSCEOSA3LED	A3	60	130,3	58	13

- 🏠 Weather resistant (IP56)
- 🔌 Electrical connection must be indoor or via IP rated electrical box



A2 MENU BOARD DESIGN STANDARD

- IT**
- Cornice a scatto angolata con bordi squadriati o arrotondati
 - Design estetico
 - Base in MFC con 4 piedini in gomma per una maggiore stabilità
- ES**
- Marco con esquinas redondeadas o unidas en inglete
 - Diseño bonito
 - Base de MFC con 4 patas de goma para mejor estabilidad
- FR**
- Cadre clic-clac avec coins biseautés ou ronds
 - Conception esthétique
 - Base MFC avec 4 pieds en caoutchouc pour une plus grande stabilité



Art. nr.	Corner shape	DIN/Size	Dimensions (cm)			
			W	H	D	KG
MBA2R25	Rounded	A2	62,5	110	39,1	8,5
MBA2G25	Mitred	A2	62,5	110	39,1	8,5



A4/A3 MENU BOARD DESIGN COMPASSO®

- IT**
 - Design Unico Cornice a Scatto Compasso®
 - Durata estrema
 - Resa estetica
- ES**
 - Diseño único de marco abatible Compasso®
 - Gran durabilidad
 - Look elegante
- FR**
 - Conception unique du cadre clic-clac Compasso®
 - Résistance extrême
 - Aspect esthétique

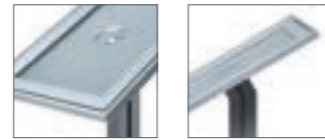

Art. nr.	DIN/Size	Dimensions (cm)			
		W	H	D	KG
MBA3G37	A3	35,1	111	40,5	8,8
MBA4G37	A4	35,1	111	40,5	6,3

A4/A3 MENU BOARD DESIGN STANDARD

BESTSELLER

- IT**
 - Palo in alluminio angolato con classica Cornice a Scatto
 - Base: MFC (argento) o base in acciaio (nero)
 - Copertura locandina stabile ai raggi UV e antiriflesso
- ES**
 - Un poste de aluminio con marco abatible
 - Base: MFC (plata) o base de acero (negro)
 - Frontal anti-UV y antirreflejos
- FR**
 - Poteau en aluminium incliné avec cadre clic-clac classique
 - Base: MFC (argent) o base en acier (noir)
 - Film antireflet résistant aux UV



Art. nr.	Corner shape	DIN/Size	Dimensions (cm)			
			W	H	D	KG
MBA3G25	Mitred	A3	33	110	39,1	5,5
MBA3R25	Rounded	A3	33	110	39,1	5,5
MBA4G25	Mitred	A4	30	108	29,2	2,8
MBA4R25	Rounded	A4	30	108	29,2	2,7
MBA3G25C9005	Mitred	A3	33	110	39,1	5,5
MBA4G25C9005	Mitred	A4	30	108	29,2	2,8

See chapter 1. Poster Frames and Displays for more displays (p. 10)

Natura Chalk Board Classic (p. 108/ch. 7) and A4/A3 Menu Board Design Standard (p. 129/ch. 8)

RINGBINDER MENU STAND

- IT**
 - Costruito con Raccoglitore ad anelli per circa 200 pagine in A4
 - Può essere personalizzato con l'opzione pannello per il logo
 - Base quadrata con gommini
- ES**
 - Anillas interreceptáculos de capacidad de hasta 200 páginas de formato DIN A4
 - Apropiado para branding con panel superior para su logotipo o marca
 - Base cuadrada con goma
- FR**
 - Equipé d'un Ringbinder pour environ 200 pages A4
 - Adapté au branding avec panneau pour logo en option
 - Base carrée avec caoutchouc



Art. nr.	DIN/Size	Dimensions (cm)			
		W	H	D	KG
MBCLIP2xA4	2 x A4	48,9	107	45	8,4

Round base on request

132 See chapter 1. Poster Frames and Displays for more displays (p. 10)



SCRITTO® MENU STAND

- IT**
 - In polipropilene durevole
 - Rapida sostituzione del contenuto
 - Espositore porta menù da tavolo ideale
- ES**
 - Fabricado en polipropileno duradero
 - Cambio de contenido rápido
 - Display de mesa ideal
- FR**
 - Réalisé en polypropylène résistant
 - Remplacement rapide du contenu
 - Présentoir de table idéal



Art. nr.	☒	DIN/Size	Dimensions (cm)			
			W	H	D	KG
TA5PBLACK	●	A5	16,1	23,5	5,5	0,2
TA6PBLACK	●	A6	11,8	17	5,5	0,1
LA5PBLACK	●	A5	15,5	22,2	5,5	0,2
LA6PBLACK	●	A6	11,2	16,2	5	0,1
TA5PWHITE	○	A5	16,1	23,5	5,5	0,2
TA6PWHITE	○	A6	11,8	17	5,5	0,1
LA5PWHITE	○	A5	15,5	22,2	5,5	0,2
LA6PWHITE	○	A6	11,2	16,2	5	0,1



SCRITTO® L STAND

BESTSELLER

- IT**
 - Duraturo e preciso
 - Opzione stampa serigrafica del logo su richiesta
 - In formato orizzontale o verticale
- ES**
 - Duradero y preciso
 - Posibilidad de solicitar serigrafía de su logo bajo petición
 - Formato vertical u horizontal
- FR**
 - Résistant et précis
 - Option d'impression du logo sur le présentoir à la demande
 - Format portrait ou paysage



Art. nr.	☒	DIN/Size	Dimensions (cm)			
			W	H	D	KG
LA6P	☐	A6	11,9	14,7	6,3	0,1
LA5P	☐	A5	16,4	20,6	8,6	0,1
LA4P	☐	A4	21,4	29,2	10	0,3
LA6L	☐	A6	16,3	10,7	5,8	0,1



MENU CARD HOLDER

- IT**
 - Effetto Premium
 - Base convessa in alluminio anodizzato argento
 - Fogli facili da inserire
- ES**
 - Look Premium
 - Forma de base convexa de aluminio anodizado en plata
 - Fácil inserción de hojas
- FR**
 - Look Premium
 - Base convexe en aluminium argenté anodisé
 - Insertion simple des feuilles



Art. nr.	☒	DIN/Size	Dimensions (cm)			
			W	H	D	KG
MCHXA5V	☐	1 x A5	14,8	22,1	8,4	0,3
MCHXA4V	☐	1 x A4	21	30,8	8,4	0,5
MCHXA5H	☐	1 x A5	21	15,9	8,4	0,3
MCHXA4H	☐	1 x A4	29,7	22,1	8,4	0,5



L STAND

- IT**
 - In acrilico trasparente
 - Duraturo e preciso
 - Opzione stampa serigrafica del logo su richiesta
- ES**
 - Acrílico transparente
 - Duradero y preciso
 - Posibilidad de solicitar serigrafía de su logo bajo petición
- FR**
 - Acrylique clair
 - Résistant et précis
 - Option d'impression du logo sur le présentoir à la demande



Art. nr.	☒	DIN/Size	Dimensions (cm)			
			W	H	D	KG
LA6PXV	☐	A6	10,5	14,6	5,6	0,1
LA5PXV	☐	A5	14,8	20,3	7,7	0,2
LA4PXV	☐	A4	21	28,7	10,7	0,3
LA6PXS	☐	A6	14,8	10,5	4,1	0,1
LA5PXS	☐	A5	21	14,6	5,6	0,2
LA4PXS	☐	A4	29,7	20,3	7,7	0,3



A STAND

- IT**
- In acrilico trasparente ripiegato
 - Fogli informativi facili da sostituire
 - In formato orizzontale o verticale
- ES**
- Acrílico transparente doblado
 - Fácil de cambiar la hoja de información
 - Formato vertical u horizontal
- FR**
- Acrylique plié clair
 - Changement simple de la feuille d'information
 - Format portait ou paysage



Art. nr.	Icon	DIN/Size	Dimensions (cm)			
			W	H	D	KG
AA4PXV	□	A4	21	29,6	13,4	0,6
AA7PXS	□	A7	10,5	7,7	3,7	0,1
AA6PXS	□	A6	14,8	10,9	5,1	0,1
AA5PXS	□	A5	21	15,1	6,9	0,4
AA4PXS	□	A4	29,7	21,1	9,6	0,5



T STAND

- IT**
- Duraturo e preciso
 - Di facile utilizzo
 - In formato orizzontale o verticale
- ES**
- Acrílico transparente
 - Fácil de usar
 - Formato vertical u horizontal
- FR**
- Acrylique plié clair
 - Simple à utiliser
 - Format portait ou paysage



Art. nr.	Icon	DIN/Size	Dimensions (cm)			
			W	H	D	KG
TA7PXV	□	A7	7,4	10,9	5,5	0,1
TA6PXV	□	A6	10,5	15,2	5,5	0,1
TA5PXV	□	A5	14,8	21,4	6,5	0,2
TA4PXV	□	A4	21	30,2	5,5	0,3
TA3PXV	□	A3	29,7	42,5	5,5	0,9
TA7PXS	□	A7	10,5	7,9	6,5	0,1
TA6PXS	□	A6	14,8	10,9	6,5	0,1
TA5PXS	□	A5	21	15,2	6,5	0,2
TA4PXS	□	A4	29,7	21,4	6,5	0,4



SCRITTO® T STAND

- IT**
- In polistirolo trasparente
 - Duraturo e preciso
 - Di facile utilizzo
- ES**
- Fabricado de poliestireno transparente
 - Duradero y preciso
 - Fácil de usar
- FR**
- Réalisé en polystyrène clair
 - Résistant et précis
 - Simple à utiliser



Art. nr.	Icon	DIN/Size	Dimensions (cm)			
			W	H	D	KG
TA5P	□	A5	16,2	24,9	6	0,2
TA4P	□	A4	22,5	34,5	7	0,5



MAGNETIC T-STAND / TICKET HOLDER

- IT**
- Design Premium con una base spessa 8 mm
 - Facile accesso - connessione pannello magnetico
 - Con o senza base
- ES**
- Diseño Premium con la base de 8 mm de grosor
 - Acceso fácil - panel de conexión magnética
 - Con o sin base
- FR**
- Conception Premium avec base de 8 mm
 - Accès simple - fixation par panneau magnétique
 - Avec ou sans base



Art. nr.	Icon	DIN/Size	Dimensions (cm)			
			W	H	D	KG
MAHTA6P	□	1 x A6	10,6	15,7	3,5	0,3
MAHTA5P	□	1 x A5	14,9	21,9	4	0,4
MAHTA4P	□	1 x A4	21,1	30,6	5	0,8
MAHA7	□	1 x A7	7,5	10,6	1,6	0,3
MAHA6	□	1 x A6	10,6	14,9	1,6	0,4
MAHA5	□	1 x A5	14,9	21,1	1,6	0,7
MAHA4	□	1 x A4	21,1	29,8	2,4	1,9



ROLL-BANNER MINI

- IT**
- Alternativa originale a un cartello informativo
 - Design minimalista e accattivante
 - Cassetta con tappi laterali cromati
- ES**
- Alternativa original a un letrero de información
 - Diseño minimalista y llamativo
 - Base con tapas laterales cromadas
- FR**
- Alternative originale à un poster d'information
 - Conception minimaliste et accrocheuse
 - Casette avec cache latéral chromé



Art. nr.	DIN/Size	Dimensions (cm)		
		W	H	KG
RBMA4	A4	21	29,7	0,4
RBMA3	A3	29,7	42	0,5



Graphic available



PLACEMATS

- IT**
- Set di 6 pezzi
 - Facile da pulire, lavabile e resistente all'acqua
 - Superficie opaca
- ES**
- Fácil de limpiar, lavable y resistente al agua
 - Superficie mate
 - Juego de 6 piezas
- FR**
- Faciles à nettoyer, lavables et résistants à l'eau
 - Surface mate
 - Ensemble de 6 pièces



Art. nr.	DIN/Size	Dimensions (cm)		
		W	H	KG
PLM6	45 x 32	45	32	1,6



9. OUTDOOR EQUIPMENT

Prodotti per uso esterno
Equipamiento para Exterior
Équipement Extérieur

Outdoor equipment is the solution for every audience at the right time. Durable and weather resistant solutions for every outdoor activity and promotion. A great variety of products. Commonly used in the hospitality, office, retail and event markets.

INDEX

9.1 Outdoor Equipment **142**
Prodotti per uso esterno
Equipamiento para Exterior
Équipement Extérieur

- **FREESTANDING AND WALL MOUNTING OPTIONS**
- **VARIOUS DESIGNS TO SUIT A WIDE RANGE OF MARKETS**
- **EASY AND QUICK TO INSTALL**

BICYCLE STAND

- IT**
 - Stabilità eccellente
 - Ideale per applicazioni commerciali fuori dagli uffici e dai negozi
 - In acciaio zincato
- ES**
 - Perfecta estabilidad
 - Ideal para uso comercial en los exteriores de oficinas o tiendas
 - Acero galvanizado
- FR**
 - Excellente stabilité
 - Idéal pour les applications commerciales en dehors des bureaux et des magasins
 - Acier galvanisé



Art. nr.	Dimensions (cm)			
	W	H	D	KG
BCSE	105	42	54,4	19,8

ROUNDED BIN

- IT**
 - Cestino della spazzatura da pavimento in acciaio
 - Inserto posacenere in acciaio inox
 - Facile da aprire e da pulire
- ES**
 - Papelera de acero independiente
 - Tapa superior con cenicero de acero inoxidable
 - Fácil de abrir y limpiar
- FR**
 - Poubelle sur pied en acier
 - Dessus de cendrier en acier inoxydable
 - Facile à ouvrir et à nettoyer



Art. nr.	Dimensions (cm)			
	W	H	D	KG
SMCSS	25	60	25	4,3

SMOKING TABLE FREESTANDING

- IT**
 - Resistente alle intemperie e agli incendi
 - Base in acciaio inox resistente
 - Completamente assemblato e pronto all'uso
- ES**
 - Resistente a la intemperie y las quemaduras
 - Base de acero inoxidable de gran resistencia
 - Montada y lista para usar
- FR**
 - Résistant aux intempéries et au feu
 - Base en acier inoxydable pour utilisation intensive
 - Entièrement assemblée et prête à l'emploi



Art. nr.	DIN/Size	Dimensions (cm)			
		W	H	D	KG
SMT70X110	105,5 x 29,7 cm	70	118,3	70	33,8

RECTANGULAR ASHTRAY

- IT**
 - Struttura rettangolare da fissare alla parete
 - Finitura in alluminio spazzolato
 - Con chiusura di sicurezza per evitare l'uso improprio
- ES**
 - Construcción rectangular para montaje en pared
 - Acabado en aluminio pulido
 - Con cerradura de seguridad contra el uso indebido
- FR**
 - Construction rectangulaire pour montage mural
 - Finition en aluminium brossé
 - Verrou de sécurité contre toute utilisation abusive



Art. nr.	Dimensions (cm)			
	W	H	D	KG
SMWS	8	48	10,8	1,7

CYLINDRICAL ASHTRAY

- IT**
 - Aspetto sottile cilindrico
 - Facile da fissare alla parete
 - Spazzola inclusa per una facile pulizia
- ES**
 - Aspecto cilíndrico y fino
 - Fácil montaje en la pared
 - Cepillo de limpieza incluido
- FR**
 - Aspect cylindrique fin
 - Fixation murale facile
 - Brosse incluse pour un nettoyage facile



Art. nr.	Dimensions (cm)			
	W	H	D	KG
SMWR	8	48	10,8	1,3

BESTSELLER

CYLINDRICAL ASHTRAY POST STAINLESS STEEL

- EN**
- Posacenere in acciaio inox da terra
 - Chiusura di sicurezza protettiva
 - Fori preimpostati per fissaggio a terra

- ES**
- Cenicero de pie de acero inoxidable
 - Cerradura de seguridad para protección
 - Orificios de fijación para instalación

- FR**
- Cendrier en acier inoxydable sur pied
 - Verrou de sécurité pour la protection
 - Trous prépercés pour une fixation au sol



BESTSELLER

Art. nr.	Dimensions (cm)			
	W	H	D	KG
SMPSS	18	90	18	7,5



FREESTANDING ASHTRAY

- EN**
- Posacenere da terra con struttura in acciaio
 - Accesso da quattro lati
 - Design antivandalismo

- ES**
- Cenicero de pie con construcción de acero
 - Acceso por las cuatro caras
 - Diseño antivandálico

- FR**
- Cendrier sur pied en acier
 - Accès des quatre côtés
 - Conception anti-vandalisme



Art. nr.	Dimensions (cm)			
	W	H	D	KG
SMPBL	21	120	21	10,8



FREESTANDING ASHTRAY WITH BIN

- EN**
- Posacenere da terra con struttura in acciaio
 - Combinazione posacenere e cestino
 - Di colore nero elegante

- ES**
- Cenicero de pie con construcción de acero
 - Cenicero y papelera al mismo tiempo
 - Color negro elegante

- FR**
- Cendrier sur pied en acier
 - Cendrier et poubelle tout-en-un
 - Élégante couleur noire



Art. nr.	Dimensions (cm)			
	W	H	D	KG
SMRBSBL	31,5	120	31,5	12,6



OFFICE

Ufficio
Oficina
Bureau



Efficient and effective: That's what matters for all visual communication products for the office industry. The diverse range of products makes it easy to create a perfectly organised, highly visible and pleasant atmosphere for sharing information.

INDOOR/OUTDOOR LOCKABLE SHOWCASES

See 10. Lockable Notice Boards page 152 & 158



BROCHURE HOLDERS
See 14. Brochure Holders page 190



NEW



INDOOR LOCKABLE SHOWCASE WITH SLIDING DOORS SLIM WITH SAFETY CORNERS

See 10. Lockable Notice Boards page 153



A4/A3 MENU BOARD DESIGN STANDARD
See 8. Menu Displays page 133



SCRITTO® WHITEBOARD

See 11. Flipcharts and Writable Boards page 167



SCRITTO® GLASSBOARD

See 11. Flipcharts and Writable Boards page 168

COMBI BOARD – ALU WHITEBOARD / CORK

See 11. Flipcharts and Writable Boards page 171

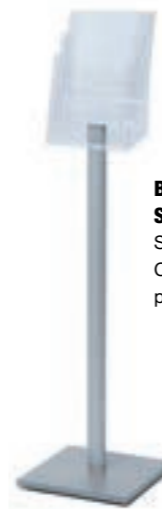

BROCHURE HOLDER DESIGN STANDARD

See 6. Leaflet and Catalogue Holders page 98



ALUMINIUM A-BOARDS

See 5. Pavement Signs page 84



WOODEN CHALK A-BOARDS

See 7. Wooden Signs page 115



CYLINDRICAL ASHTRAY

See 9. Outdoor Equipment page 143



WAYFINDING SYSTEM CURVED

See 12. Wayfinding Systems page 179



GLASS SHOWCASE ILLUMINATED

See 13. Glass Showcases page 188

interesting categories for you

1. POSTER FRAMES AND DISPLAYS	10
2. TEXTILE FRAMES	36
4. DIGITAL DISPLAYS	62
5. PAVEMENT SIGNS	82
6. LEAFLET AND CATALOGUE HOLDERS	96
7. WOODEN SIGNS	108
8. MENU DISPLAYS	122
9. OUTDOOR EQUIPMENT	140
10. LOCKABLE NOTICE BOARDS	148
11. FLIPCHARTS AND WRITABLE BOARDS	164
12. WAYFINDING SYSTEMS	176
13. GLASS SHOWCASES	186
14. BROCHURE HOLDERS	190
15. BANNERS	202
16. FLAGS	230

10. LOCKABLE NOTICE BOARDS

Bacheche con serratura
Tablones de anuncios con cerradura
Tableaux d'affichage verrouillables

Lockable Notice Boards are designed to keep public messages and information secure and free from tampering. A variety of anodised aluminium profiles designed for indoor and outdoor use, formats in 1 x A4 up to 27 x A4, RAL-colour options and even fire-retardant materials.

- ✦ **GUARANTEED MAXIMUM SAFETY AND ESG SAFETY GLASS PROTECTION**
- ✦ **VARIOUS OPTIONS: CORK, MAGNETIC OR PLASTIC BACKWALL**
- ✦ **INDOOR AND OUTDOOR VARIATIONS WITH OPTIONAL LED ILLUMINATION AND IP RATING**



INDEX

10.1 Indoor Lockable Notice Boards **152**
Bacheche con serratura da interno
Tablones de anuncios de interior con cerradura
Tableaux d'affichage intérieurs avec système de verrouillage

10.2 Outdoor Lockable Notice Boards **158**
Bacheche con serratura da esterno
Tablones de anuncios de exterior con cerradura
Tableaux d'affichage extérieurs avec système de verrouillage



GOOD

INDOOR LOCKABLE SHOWCASE ECONOMY

- Cost efficient and durable
- Lockable hinged door with 2 keys
- Magnetic white coated steel or cork back wall



BETTER

INDOOR LOCKABLE SHOWCASE

- Suitable for indoor and sheltered outdoor areas
- High impact PS clear front panel
- Dry wipe magnetic back panel for markers and magnets



BEST

INDOOR LOCKABLE SHOWCASE WITH SLIDING DOORS SLIM

- Sliding security glass doors
- Slim and elegant look
- Writable and for magnet use



LOCKABLE NOTICE BOARDS

- Available in silver anodised aluminium as standard
- Fire rated
- RAL paint colours and printed headers on request
- Lockable front panels supplied with 2 keys per lock

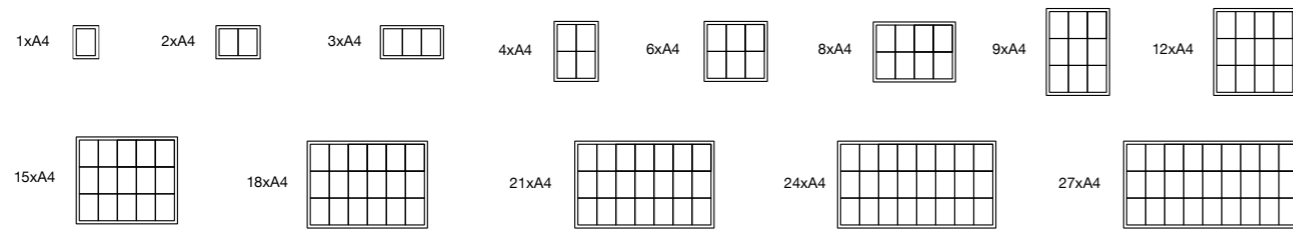

Profiles XS

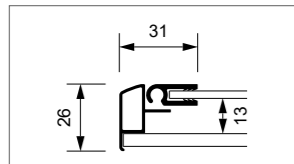

Profiles SL

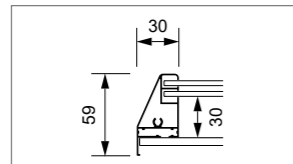

Profiles SLG

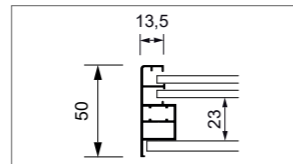

Profiles S

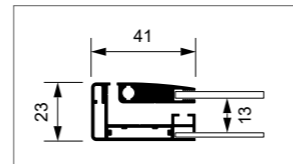

Profiles PX

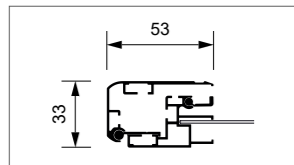

Profiles P

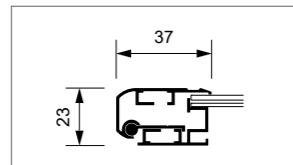

Profiles SCG

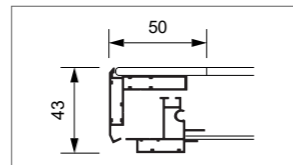

Profiles SCEOS

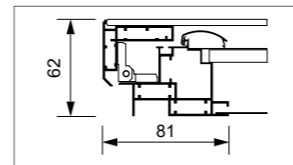

Profiles TE

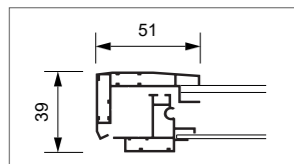
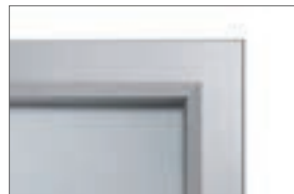

Profiles T

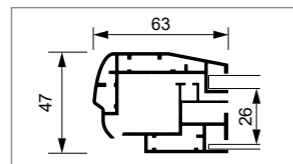

Profiles L

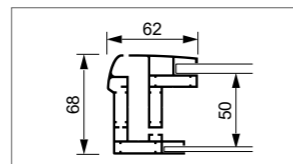

INDOOR LOCKABLE SHOWCASE ECONOMY

BESTSELLER

- IT**
- Economica e durevole
 - Anta a battente con serratura con 2 chiavi
 - Fondo in acciaio verniciato bianco magnetico
- ES**
- Rentable y duradera
 - Puerta abisagrada con cerradura y 2 llaves
 - Trasera metálica con revestimiento magnético
- FR**
- Economique et durable
 - Porte à charnières verrouillable avec 2 clés
 - Panneau arrière magnétique en acier thermolaqué



Art. nr.	DIN/Size	Dimensions (cm)			KG
		W	H	D	
Fire rated B1					
SCXS1XA4B1	1 x A4	27,1	35	2,6	1,1
SCXS2XA4B1	2 x A4	49,1	35	2,6	1,6
SCXS3XA4B1	3 x A4	71,1	35	2,6	2,4
SCXS4XA4B1	4 x A4	49,1	65,5	2,6	3
SCXS6XA4B1	6 x A4	71,1	65,5	2,6	4,1
SCXS8XA4B1	8 x A4	93,1	65,5	2,6	5,3
SCXS9XA4B1	9 x A4	71,1	96,3	2,6	5,9
SCXS12XA4B1	12 x A4	93,1	96,3	2,6	7,6
SCXS1XA4	1 x A4	27,1	35	2,6	1
SCXS2XA4	2 x A4	49,1	35	2,6	1,6
SCXS3XA4	3 x A4	71,1	35	2,6	2,2
SCXS4XA4	4 x A4	49,1	65,5	2,6	2,8
SCXS6XA4	6 x A4	71,1	65,5	2,6	3,9
SCXS8XA4	8 x A4	93,1	65,5	2,6	5
SCXS9XA4	9 x A4	71,1	96,3	2,6	5,7
SCXS12XA4	12 x A4	93,1	96,3	2,6	7,3
SCXS1XA4C9005	1 x A4	27,1	35	2,6	1
SCXS2XA4C9005	2 x A4	49,1	35	2,6	1,6
SCXS3XA4C9005	3 x A4	71,1	35	2,6	2,2
SCXS4XA4C9005	4 x A4	49,1	65,5	2,6	2,8
SCXS6XA4C9005	6 x A4	71,1	65,5	2,6	3,9
SCXS8XA4C9005	8 x A4	93,1	65,5	2,6	5
SCXS9XA4C9005	9 x A4	71,1	96,3	2,6	5,7
SCXS12XA4C9005	12 x A4	93,1	96,3	2,6	7,3

12 mm internal depth

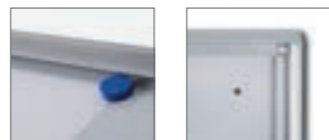

CORK INDOOR LOCKABLE SHOWCASE ECONOMY

- IT**
- Pannello frontale in acrilico
 - Profondità interna di 12 mm
 - Economica e durevole
- ES**
- Panel frontal acrílico
 - Profundidad: 12 mm
 - Rentable y duradera
- FR**
- Plaque frontale en acrylique
 - Profondeur interne de 12 mm
 - Economique et durable



Art. nr.	DIN/Size	Dimensions (cm)			KG
		W	H	D	
SCXSC4XA4	4 x A4	49,1	65,5	2,6	3,4
SCXSC6XA4	6 x A4	71,1	65,5	2,6	4,6
SCXSC8XA4	8 x A4	93,1	65,5	2,6	5,7
SCXSC9XA4	9 x A4	71,1	96,3	2,6	6,4
SCXSC12XA4	12 x A4	93,1	96,3	2,6	8



See accessory page for options (p. 168)

INDOOR LOCKABLE SHOWCASE WITH SLIDING DOORS SLIM WITH SAFETY CORNERS

NEW

- IT**
- Ante in vetro di sicurezza scorrevoli da 4 mm (ESG)
 - Con angolari in plastica arrotondati ABS per la sicurezza
 - Per utilizzo interno certificata B1
- ES**
- Puertas correderas de cristal templado de 4 mm (ESG)
 - Esquinas redondeadas de plástico ABS para mayor seguridad
 - Para uso en interiores Certificado B1
- FR**
- Portes coulissantes en verre de sécurité de 4 mm (ESG)
 - Coins arrondis en plastique ABS pour la sécurité
 - Pour un usage intérieur certifié B1



Art. nr.	DIN/Size	Dimensions (cm)			KG
		W	H	D	
SCSLR6xA4	6 x A4	68,6	64,1	5	8,7
SCSLR8xA4	8 x A4	90,6	64,1	5	11
SCSLR10xA4	10 x A4	112,6	64,1	5	13,4
SCSLR12xA4	12 x A4	90,6	94,8	5	15,5
SCSLR15xA4	15 x A4	112,6	94,8	5	18,7
SCSLR18xA4	18 x A4	134,6	94,8	5	22
SCSLR21xA4	21 x A4	156,6	94,8	5	25,2
SCSLR24xA4	24 x A4	178,1	94,8	5	28,4

With safety corners



INDOOR LOCKABLE SHOWCASE WITH SLIDING DOORS

- IT**
- Profondità interna 30 mm
 - Classificazione antincendio
 - Pannelli frontali scorrevoli trasparenti in vetro temperato di sicurezza da 4 mm con serratura
- ES**
- Profundidad: 30 mm
 - Ignífuga
 - Puertas correderas de cristal templado anti-impactos de 4 mm con cerradura
- FR**
- Profondeur interne de 30 mm
 - Résistance au feu
 - Panneaux avant coulissants en verre de sécurité trempé transparent de 4 mm verrouillables



Art. nr.	DIN/Size	Dimensions (cm)			KG
		W	H	D	
SCSL6xA4	6 x A4	72	67,5	5,9	10,6
SCSL8xA4	8 x A4	94	67,5	5,9	12,4
SCSL9xA4	9 x A4	72	98,2	5,9	13,4
SCSL10xA4	10 x A4	116	67,5	5,9	14,8
SCSL12xA4	12 x A4	94	98,2	5,9	17,4
SCSL15xA4	15 x A4	116	98,2	5,9	20,8
SCSL18xA4	18 x A4	138	98,2	5,9	24,4
SCSL21xA4	21 x A4	160	98,2	5,9	28,2
SCSL24xA4	24 x A4	181,5	98,2	5,9	31,8

Ideal for schools
With safety corners



Available with premium paper graphics

See accessory page for options (p. 162)



INDOOR LOCKABLE SHOWCASE WITH SLIDING DOORS SLIM

- IT**
- Ante in vetro di sicurezza scorrevoli
 - Aspetto sottile ed elegante
 - Scrivibile e magnetica
- ES**
- Puertas correderas de cristal templado
 - Diseño fino y elegante
 - Para uso de imanes y rotuladores
- FR**
- Portes coulissantes en verre de sécurité
 - Aspect fin et élégant
 - Inscriptible et utilisable avec aimant

Art. nr.	DIN/Size	Dimensions (cm)			
		W	H	D	KG
SCSLG6xA4	6 x A4	68,6	64,1	5	10,6
SCSLG8xA4	8 x A4	90,6	64,1	5	12,4
SCSLG10xA4	10 x A4	112,6	64,1	5	14,8
SCSLG12xA4	12 x A4	90,6	94,8	5	17,4
SCSLG15xA4	15 x A4	112,6	94,8	5	20,8
SCSLG18xA4	18 x A4	134,6	94,8	5	24,4
SCSLG21xA4	21 x A4	156,6	94,8	5	28,2
SCSLG24xA4	24 x A4	178,1	94,8	5	31,8
SCSLG6xA4C7016JS	6 x A4	68,6	64,1	5	10,6
SCSLG8xA4C7016JS	8 x A4	90,6	64,1	5	12,4
SCSLG10xA4C7016JS	10 x A4	112,6	64,1	5	14,8
SCSLG12xA4C7016JS	12 x A4	90,6	94,8	5	17,4
SCSLG15xA4C7016JS	15 x A4	112,6	94,8	5	20,8
SCSLG18xA4C7016JS	18 x A4	134,6	94,8	5	24,4
SCSLG21xA4C7016JS	21 x A4	156,6	94,8	5	28,2
SCSLG24xA4C7016JS	24 x A4	178,1	94,8	5	31,8



INDOOR LOCKABLE SHOWCASE

- IT**
- Adatto per aree interne ed esterne riparate
 - Pannello frontale trasparente in polistirene antiurto
 - Pannello posteriore magnetico pulibile a secco per pennarelli e magneti
- ES**
- Apropiada para uso interior y zonas exteriores cubiertas
 - Panel frontal de poliestireno transparente de gran impacto
 - Panel magnético que permite escribir con rotuladores y uso de imanes
- FR**
- Convient aux espaces intérieurs et extérieurs abrités
 - Panneau avant transparent PS à fort impact
 - Panneau arrière magnétique effaçable à sec pour marqueurs et aimants



Art. nr.	DIN/Size	Dimensions (cm)			
		W	H	D	KG
Fire rated B1					
SCS2xA4B1	2 x A4	52,1	38,8	2,3	3
SCS3xA4B1	3 x A4	74,1	38,8	2,3	4,4
SCS4xA4B1	4 x A4	52,1	69,6	2,3	4,8
SCS6xA4B1	6 x A4	74,1	69,6	2,3	6,9
SCS8xA4B1	8 x A4	96,1	69,6	2,3	7,9
SCS9xA4B1	9 x A4	74,1	100,4	2,3	9,6
SCS12xA4B1	12 x A4	96,9	100,4	2,3	10,7
SCS2xA4	2 x A4	52,1	38,8	2,3	3
SCS3xA4	3 x A4	74,1	38,8	2,3	3,6
SCS4xA4	4 x A4	52,1	69,6	2,3	4,7
SCS6xA4	6 x A4	74,1	69,6	2,3	6,8
SCS8xA4	8 x A4	96,1	69,6	2,3	7,7
SCS9xA4	9 x A4	74,1	100,4	2,3	9,3
SCS12xA4	12 x A4	96,9	100,4	2,3	10,4

Art. nr.	DIN/Size	Dimensions (cm)			
		W	H	D	KG
SCS2xA4C9005	2 x A4	52,1	38,8	2,3	3
SCS3xA4C9005	3 x A4	74,1	38,8	2,3	4,4
SCS4xA4C9005	4 x A4	52,1	69,6	2,3	4,8
SCS6xA4C9005	6 x A4	74,1	69,6	2,3	6,9
SCS8xA4C9005	8 x A4	96,1	69,6	2,3	7,9
SCS9xA4C9005	9 x A4	74,1	100,4	2,3	9,6
SCS12xA4C9005	12 x A4	96,9	100,4	2,3	10,7
SCS2xA4C7016JS	2 x A4	52,1	38,8	2,3	3
SCS3xA4C7016JS	3 x A4	74,1	38,8	2,3	3,6
SCS4xA4C7016JS	4 x A4	52,1	69,6	2,3	4,7
SCS6xA4C7016JS	6 x A4	74,1	69,6	2,3	6,8
SCS8xA4C7016JS	8 x A4	96,1	69,6	2,3	7,7
SCS9xA4C7016JS	9 x A4	74,1	100,4	2,3	9,3
SCS12xA4C7016JS	12 x A4	96,9	100,4	2,3	10,4



LOCKABLE POSTER CASE ECONOMY

BESTSELLER

- IT**
- Bachecca con serratura che offre una maggiore sicurezza
 - Resistente agli urti
 - Profilo da 37 mm con fondo in plastica
- ES**
- Un Portaposter con el cierre de seguridad mejorado
 - Resistente al impacto
 - Perfil de 37 mm con pared posterior de plástico
- FR**
- Vergrendelbare poster case met verbeterde beveiliging
 - Schokbestendig
 - 37 mm profiel met kunststof achterwand



Art. nr.	DIN/Size	Dimensions (cm)			KG
		W	H	D	
SCPA4	A4	26,6	35,3	2,3	1,5
SCPA3	A3	35,3	47,6	2,3	2
SCPA2	A2	47,6	65	2,3	2,8
SCPA1	A1	65	89,7	2,3	4,2
SCPA0	A0	89,7	124,5	2,3	6,6
SCP50x70	50 x 70	55,6	75,6	2,3	3,4
SCP70x100	70 x 100	75,6	105,6	2,3	5,2

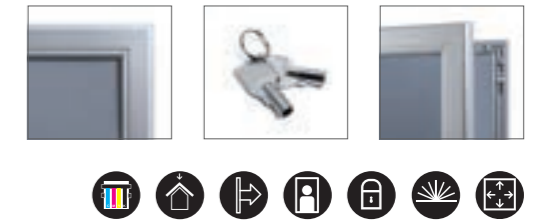

LOCKABLE POSTER CASE WITH GALVANISED BACKWALL

BESTSELLER

- IT**
- Cornice pubblicitaria con maggiore sicurezza
 - Resistente agli urti
 - Profilo da 53 mm
- ES**
- Seguridad de marco para gráfica aumentada
 - Resistente al impacto
 - Perfil de 53 mm
- FR**
- Cadre de sécurité améliorée pour poster
 - Résistant aux chocs
 - Profil 53 mm



Art. nr.	DIN/Size	Dimensions (cm)			KG
		W	H	D	
SCPXA4	A4	30	38,7	3,3	2,8
SCPXA3	A3	38,7	51	3,3	3,5
SCPXA2	A2	51	68,4	3,3	4,7
SCPXA1	A1	68,4	93,1	3,3	5,9
SCPXA0	A0	93,1	127,9	3,3	10,6
SCPX50x70	50 x 70	59	79	3,3	5,6
SCPX70x100	70 x 100	79	109	3,3	8,5



Available with premium paper graphics

See accessory page for options (p. 162)

157

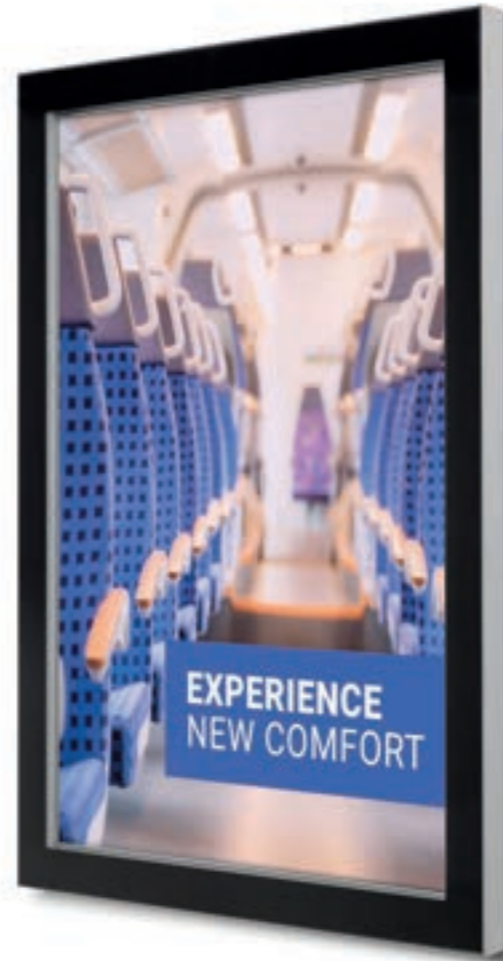

OUTDOOR PREMIUM POSTER CASE SLIM

- IT**
- Design premium con stampa in ceramica nera sul vetro anteriore
 - Design sofisticato e sottile da 48 mm
 - Locandine sempre in ordine grazie al fondo magnetico
- ES**
- Diseño premium con una impresión de color negro en el cristal frontal
 - Diseño fino y sofisticado de 48 mm
 - Las gráficas siempre en su sitio gracias a la trasera magnética
- FR**
- Un design haut de gamme avec impression en céramique noire sur la vitre avant
 - Design raffiné et fin de 48 mm
 - Les affiches resteront à leur place grâce à la paroi arrière magnétique

Art. nr.	DIN/Size	Dimensions (cm)			
		W	H	D	KG
SCGA3	A3	49,9	37,6	4,5	7,1
SCGA2	A2	67,3	49,9	4,5	8,8
SCGA1	A1	92	67,3	4,5	12
SCG50x70	50 x 70	77,9	57,9	4,5	10,5
SCG70x100	70 x 100	107,9	77,9	4,5	15,8



LED OUTDOOR PREMIUM POSTER CASE FREESTANDING

- IT**
- Autoportante
 - Illuminazione LED intensa 24/7
 - Bifacciale
- ES**
- Tótem porta póster
 - Iluminación LED radiante en todo momento
 - De doble cara
- FR**
- Sur pied
 - Eclairage LED 24/7
 - Double face



Art. nr.	DIN/Size	Dimensions (cm)			
		W	H	D	KG
SCEOSA0DLED	A0	102,5	185	22,3	95
SCEOS1200x1800DLED	120 x 180	138,4	240	22,3	145,1

- Other sizes and colours on request
- Electrical connection must be indoor or via IP rated electrical box
- 220V power cable must be prepared before installation



OUTDOOR LOCKABLE SHOWCASE ILLUMINATED LOGO

- IT**
- Illuminata da una striscia LED da 12/14V
 - Resistente alle intemperie
 - Può essere personalizzata
- ES**
- Iluminada con tira LED 12/24V
 - Resistente a la intemperie
 - Lista para branding
- FR**
- Illuminée avec une bande de LED de 12/24 V
 - Résistante aux intempéries
 - Prête pour le marquage

Art. nr.	DIN/Size	Dimensions (cm)			
		W	H	D	KG
SCT4xA4PHLED	4 x A4	58,5	86	4,7	13,4
SCT6xA4PHLED	6 x A4	80,5	86	4,7	19,2
SCT8xA4PHLED	8 x A4	102,5	86	4,7	22,2
SCT9xA4PHLED	9 x A4	80,5	116,7	4,7	26,6

With gas spring

SCT12xA4PHLED	12 x A4	102,5	116,7	4,7	30,7
SCT15xA4PHLED	15 x A4	124,5	116,7	4,7	34,4
SCT18xA4PHLED	18 x A4	146,5	106,7	4,7	41,6
SCT21xA4PHLED	21 x A4	168,5	116,7	4,7	47,7
SCT24xA4PHLED	24 x A4	192,5	116,7	4,7	53,5
SCT27xA4PHLED	27 x A4	212,5	116,7	4,7	61,4

- IP56 certified fully weather resistant
- Other sizes and colours on request
- Electrical connection must be indoor or via IP rated electrical box



BESTSELLER



OUTDOOR LOCKABLE SHOWCASE

- IT**
- Bacheca esterna bestseller con durata estrema
 - Certificato IP56, completamente resistente agli agenti atmosferici
 - Certificato di resistenza al fuoco B1 DIN 4102
- ES**
- Vitrina para exteriores extremadamente duradera y la más vendida
 - Certificación IP56 de resistencia a la intemperie
 - Certificación de protección ignífuga B1 DIN 4102
- FR**
- Vitrines d'affichage pour extérieur la plus vendue avec une durabilité extrême
 - Certifiée IP56 entièrement résistante aux intempéries
 - Certificat de protection incendie B1 DIN 4102



Art. nr.	DIN/Size	Dimensions (cm)			
		W	H	D	KG
SCT4xA4PH	4 x A4	58,3	76	4,7	10,3
SCT6xA4PH	6 x A4	80,5	76	4,7	14,1
SCT8xA4PH	8 x A4	102,5	76	4,7	17,3
SCT9xA4PH	9 x A4	80,5	106,7	4,7	18,6

With gas spring

SCT12xA4PH	12 x A4	102,5	106,7	4,7	21,6
SCT15xA4PH	15 x A4	124,5	106,7	4,7	26,6
SCT18xA4PH	18 x A4	146,5	106,7	4,7	31,3
SCT21xA4PH	21 x A4	168,5	106,7	4,7	34,2
SCT24xA4PH	24 x A4	192,5	106,7	4,7	37,2
SCT27xA4PH	27 x A4	212,5	106,7	4,7	45,1

- Available in LED version with Outdoor Lockable Showcase Illuminated Logo
- Available in other RAL colours on request (blue, red, black, white)
- Optional: Posts and Feet (see p. 158)

Art. nr.	DIN/Size	Dimensions (cm)			
		W	H	D	KG
SCT9xA4PHC9005	9 x A4	80,5	106,7	4,7	18,6

With gas spring

SCT12xA4PHC9005	12 x A4	102,5	106,7	4,7	21,6
SCT15xA4PHC9005	15 x A4	124,5	106,7	4,7	26,6
SCT18xA4PHC9005	18 x A4	146,5	106,7	4,7	31,3

With gas spring

SCT4xA4PHC7016JS	4 x A4	58,3	76	4,7	10,3
SCT6xA4PHC7016JS	6 x A4	80,5	76	4,7	14,1
SCT8xA4PHC7016JS	8 x A4	102,5	76	4,7	17,3
SCT9xA4PHC7016JS	9 x A4	80,5	106,7	4,7	18,6

With gas spring

SCT12xA4PHC7016JS	12 x A4	102,5	106,7	4,7	21,6
SCT15xA4PHC7016JS	15 x A4	124,5	106,7	4,7	26,6
SCT18xA4PHC7016JS	18 x A4	146,5	106,7	4,7	31,3
SCT21xA4PHC7016JS	21 x A4	168,5	106,7	4,7	34,2
SCT24xA4PHC7016JS	24 x A4	192,5	106,7	4,7	37,2
SCT27xA4PHC7016JS	27 x A4	212,5	106,7	4,7	45,1

OUTDOOR LOCKABLE SHOWCASE SLIM

- IT**
- Certificato IP56, completamente resistente agli agenti atmosferici
 - Aspetto sottile ed elegante
 - Con fondo magnetico bianco
- ES**
- Certificación IP56 de resistencia a la intemperie
 - Diseño fino y elegante
 - Con trasera magnética de color blanco
- FR**
- Certifiée IP56 entièrement résistante aux intempéries
 - Aspect fin et élégant
 - Avec paroi arrière magnétique blanche

Art. nr.	DIN/Size	Dimensions (cm)			
		W	H	D	KG
SCTE4xA4PH	4 x A4	53	70,5	4	9,3
SCTE6xA4PH	6 x A4	75	70,5	4	12,7
SCTE8xA4PH	8 x A4	97	70,5	4	15,6
SCTE9xA4PH	9 x A4	75	101,2	4	16,7
SCTE12xA4PH	12 x A4	97	101,2	4	19,4

- Other sizes and colours on request

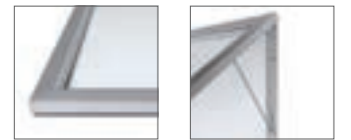

OUTDOOR LOCKABLE SHOWCASE EXTRA DEEP

- IT**
- Profondità interna di 50 mm
 - Ideale per le medaglie o articoli simili
 - Può essere fissata al muro, alle recinzioni e applicazioni con installazione autoportante
- ES**
- Profundidad: 50 mm
 - Ideal para poner medallas u objetos similares
 - Apta para instalación en paredes, vallas y postes
- FR**
- Profondeur interne de 50 mm
 - Idéal pour exposer des médailles ou des objets similaires
 - Convient aux applications murales, de clôture et sur poteau

Art. nr.	DIN/Size	Dimensions (cm)			
		W	H	D	KG
SCL6xA4PH	6 x A4	79,2	74,7	6,8	16,8
SCL8xA4PH	8 x A4	101,2	74,7	6,8	19,2
SCL9xA4PH	9 x A4	79,2	105,4	6,8	20,2
SCL12xA4PH	12 x A4	101,2	105,4	6,8	23,5
SCL15xA4PH	15 x A4	123,2	105,4	6,8	30,5
SCL18xA4PH	18 x A4	145,2	105,4	6,8	33,6
SCL21xA4PH	21 x A4	167,2	105,4	6,8	36,6
SCL24xA4PH	24 x A4	189,2	105,4	6,8	44,4
SCL27xA4PH	27 x A4	211,5	105,4	6,8	46,4

- Other sizes and colours on request
- Optional: Posts and Feet (see p. 162)



POSTS AND FEET

Accessory for Outdoor Lockable Showcase and Outdoor Lockable Showcase Extra Deep



- IT** • Gambe in alluminio anodizzato argento con diametro da 70 mm
- ES** • Pies de perfiles de aluminio en acabado anodizado plateado de 70 mm en diámetro
- FR** • Pattes de profil en aluminium anodisé argent de 70 mm de diamètre

Art. nr. SCPOST
SCPOSTP

⊕ Standard silver RAL paint colours available on request

SCRITTO® STARTER KIT

Accessory for all writable Lockable Notice Boards, Whiteboards and Glassboards



- IT** • Set di pennarelli, gomma, detergente spray e magneti
- ES** • Set de marcadores, borrador, limpiador en spray e imanes
- FR** • Ensemble de marqueurs, gomme à effacer, spray nettoyant et aimants

Art. nr. STARTERKIT

SCRITTO® MAGNETS

Accessory for all Whiteboards and magnetic/writable Lockable Notice Boards



- IT** • Set di 8 magneti, di diametro 20 mm o 35 mm. Disponibili in blu, rosso, bianco o nero
- ES** • Juego de 8 imanes, 20 mm o 35 mm en diámetro. Disponible en colores azul, rojo, blanco o negro
- FR** • Jeu de 8 aimants, diamètre de 20 mm ou 35 mm. Disponible en bleu, rouge, blanc ou noir

Art. nr. MAGNETS20BLUE
MAGNETS20RED
MAGNETS20WHITE
MAGNETS20BLACK
MAGNETS35BLUE
MAGNETS35RED
MAGNETS35WHITE
MAGNETS35BLACK



SCRITTO® PINS

Accessory for all cork Lockable Notice Boards and Pin Boards



- IT** • Set di 100 pz. - adatto a bacheche in feltro o in sughero
- ES** • Contenido: 100 Uds, Para tablonos de corcho o fieltro
- FR** • Jeu de 100 pièces, daptées aux tableaux d'affichage en liège et en feutre

Art. nr. SETPINS

MAGNETIC POCKET

Accessory for all Lockable Notice Boards



- IT** • Tasca in acrilico per posizionare locandine
- ES** • Carpeta acrílica para la colocación de los posters
- FR** • Pochette en acrylique pour placer des posters

Art. nr. SCPOCKETA4
SCPOCKETA3

⊕ Great alternative to magnets



11. FLIPCHARTS AND WRITABLE BOARDS

Flipcharts y Pizarras
Tableaux à feuilles mobiles
et tableaux inscriptibles

Flipcharts and Writable Boards are essential communication tools for sharing information and creative concepts. Products are durable and highly functional for use in conference and meeting rooms, classrooms and other settings designed for learning and communication. Markers, magnets and other accessories available.

- **PERFECT TOOL FOR SHARING IDEAS AND SUPPORT CREATIVITY**
- **FOLDABLE FOR EASY STORAGE, EXCELLENT STABILITY**
- **GREAT SOLUTION FOR OFFICES, SCHOOLS AND MEETING ROOMS**

INDEX

11.1 Flipcharts **166**
Flipcharts
Flipcharts
Tableaux à feuilles mobiles

11.2 Whiteboards and Pin Boards **167**
Lavagne riscrivibili e per puntine
Pizzarras Blancas y Tableros Anuncios
Tableaux Blancs et Tableaux d’Affichage

11.3 Accessories **174**
Accessori
Accesorios
Accessoires

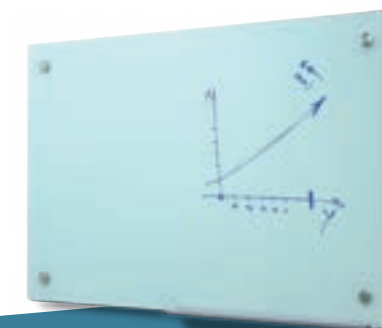

GOOD
SCRITTO® WHITEBOARD

- Suitable for magnets and marker pens
- Mounting in portrait or landscape orientation
- Ideal for using in classrooms, meeting rooms or boardrooms



BETTER
COMBI BOARD - ALU WHITEBOARD / CORK

- Classic design thanks to the aluminium frame
- Write and pin various messages and notes
- Perfect to use in office market



BEST
SCRITTO® GLASSBOARD

- Premium surface glass whiteboard
- With removable silver anodised pen tray
- Easy installation

SCRITTO® FLIPCHART STANDARD

BESTSELLER

- IT**
 - Regolabile in altezza
 - Disponibile in tre opzioni; scrivibile, magnetica o a fogli
 - Dotata di portapennarelli
- ES**
 - Altura regulable
 - Tres opciones de uso; escritura, magnético o colocación de papel
 - Bandeja para rotuladores incluida
- FR**
 - Réglable en hauteur
 - Trois options utilisateur ; feuilles inscriptibles, magnétiques ou papier
 - Rangement pour feutres



Art. nr.	DIN/Size	Dimensions (cm)				KG
		W	H	D		
FCSTN	66 x 100	89	190	82,5	12	

SCRITTO® FLIPCHART VARIO

- IT**
 - Facile da spostare grazie alle 5 ruote
 - Regolabile in altezza fino a 2,2 m
 - Disponibile in tre opzioni; scrivibile, magnetica o a fogli
- ES**
 - Fácil de mover gracias a 5 ruedas
 - Regulable altura hasta 2,2 m
 - Tres opciones de uso; escritura, magnético o colocación de papel
- FR**
 - Facile à déplacer grâce aux 5 roues
 - Réglable en hauteur jusqu'à 2,2 m
 - Trois options utilisateur ; feuilles inscriptibles, magnétiques ou papier



Art. nr.	DIN/Size	Dimensions (cm)				KG
		W	H	D		
FCVAS	66 x 100	70,6	220	58	15,5	
FCVAR	66 x 100	70,6	220	64	17,5	

SCRITTO® ECONOMY WHITEBOARD

BESTSELLER

- IT**
 - Si può posizionare sia in orizzontale sia in verticale
 - Struttura sicura e duratura
 - Adatta a magneti e pennarelli
- ES**
 - Montaje en vertical u horizontal
 - Duradera y de construcción segura
 - Apta para imanes y rotuladores
- FR**
 - Fixation en orientation portrait ou paysage
 - Construction durable et sûre
 - Convient aux aimants et aux feutres

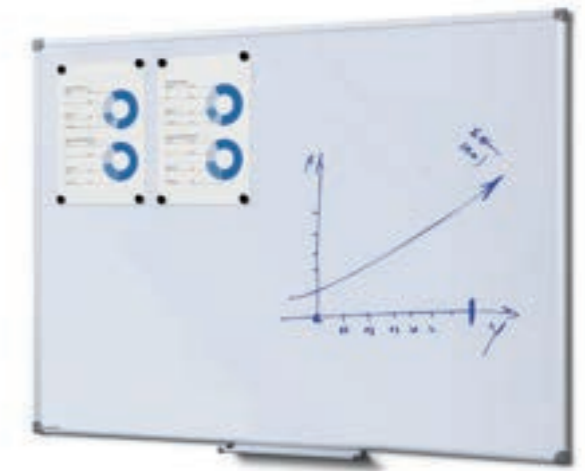

Art. nr.	DIN/Size	Dimensions (cm)				KG
		W	H	D		
WBNECS60x45	60 x 45	60	45	1,5	2	
WBNECS90x60	90 x 60	90	60	1,5	3,6	
WBNECS90x120	90 x 120	120	90	1,5	8	
WBNECS90x180	90 x 180	180	90	1,5	12	
WBNECS100x150	100 x 150	150	100	1,5	10,5	
WBNECS100x200	100 x 200	200	100	1,5	15,5	



SCRITTO® WHITEBOARD

- IT**
 - Adatta a magneti e pennarelli
 - Si può posizionare sia in orizzontale sia in verticale
 - Ideale da utilizzare in classe, sala riunioni e sala di rappresentanza
- ES**
 - Apta para imanes y rotuladores
 - Posible montaje en vertical u horizontal
 - Ideal para uso en aulas, salas de reuniones o salas de juntas
- FR**
 - Convient aux aimants et aux feutres
 - Fixation en orientation portrait ou paysage
 - Idéal pour une utilisation dans les salles de classe, les salles de réunion ou les salles de conseil



Art. nr.	DIN/Size	Dimensions (cm)				KG
		W	H	D		
WBNEES90x120	90 x 120	120	90	1,5	7,2	
WBNEES100x150	100 x 150	150	100	1,5	13	
WBNEES100x200	100 x 200	200	100	1,5	17,5	

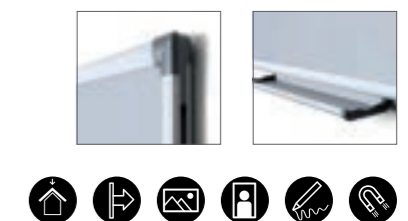



SCRITTO® GLASSBOARD

- IT**
- Lavagna bianca con superficie in vetro premium
 - Con portapennarelli anodizzato argento rimovibile
 - Facile da installare
- ES**
- Superficie de cristal Premium
 - Con bandeja extraíble anodizada plata
 - Instalación fácil
- FR**
- Tableau blanc en verre de qualité
 - Avec plumier anodisé argent amovible
 - Installation facile



Art. nr.	DIN/Size	Dimensions (cm)				KG
		W	H	D		
WBNGB90x60	○ 90 x 60	90	60	4	8,5	
WBNGB90x120	○ 90 x 120	120	90	4	17	
WBNGBBL90x60	● 90 x 60	90	60	4	7	
WBNGBBL90x120	● 90 x 120	120	90	4	15	



SCRITTO® CORKBOARD

- IT**
- Angolari di protezione
 - Cornice in alluminio duratura
 - Bachecca alveolare
- ES**
- Esquinas de seguridad
 - Marco de aluminio duradero
 - Tablón de panal para chinchetas
- FR**
- Coins de sécurité
 - Cadre en aluminium durable
 - Carte à broches Honeycomb



Art. nr.	DIN/Size	Dimensions (cm)				KG
		W	H	D		
CBN45x60	45 x 60	60	45	1,5	1,6	
CBN60x90	60 x 90	90	60	1,5	3	
CBN90x120	90 x 120	120	90	1,5	5,6	
CBN90x180	90 x 180	180	90	1,5	9	
CBN100x150	100 x 150	150	100	1,5	7,5	
CBN100x200	100 x 200	200	100	1,5	11	



SCRITTO® FABRIC BOARD

- IT**
- Sicura e duratura
 - Angolari di protezione
 - Dopo l'utilizzo i perni non lasciano alcun foro
- ES**
- Duradero y seguro
 - Esquinas de seguridad
 - Sin agujeros en tablón después del uso
- FR**
- Durable et sûr
 - Coins de sécurité
 - Pas de trous d'épingles sur le tableau après utilisation

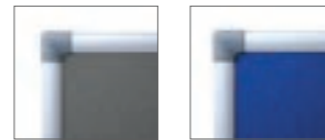

Art. nr.	DIN/Size	Dimensions (cm)			KG
		W	H	D	
FBN45x60GREY	45 x 60	60	45	1,5	1,7
FBN60x90GREY	60 x 90	90	60	1,5	2,9
FBN90x120GREY	90 x 120	120	90	1,5	6
FBN100x150GREY	100 x 150	150	100	1,5	8,4
FBN100x200GREY	100 x 200	200	100	1,5	10,8
FBN60x90BLUE	60 x 90	90	60	1,5	2,9
FBN90x120BLUE	90 x 120	120	90	1,5	6
FBN100x150BLUE	100 x 150	150	100	1,5	8,4
FBN100x200BLUE	100 x 200	200	100	1,5	10,8

See accessory page for options (p. 174)



**COMBI BOARD -
ALU WHITEBOARD / CORK**

- IT**
- Design classico grazie alla cornice in alluminio
 - Scrivi e fissa vari messaggi e note
 - Perfetta da utilizzare in ufficio
- ES**
- Diseño clásico gracias al marco de aluminio
 - Escribe y enganche varios mensajes o diferentes notas
 - Perfecto para el sector de oficinas
- FR**
- Design classique grâce au cadre en aluminium
 - Rédigez et épinglez plusieurs messages et notes
 - Parfait pour une utilisation dans les bureaux



Art. nr.	DIN/Size	Dimensions (cm)			KG
		W	H	D	
WBC900x1200	90 x 120	90	120	5,6	5,6



See accessory page for options (p. 174)



COMBI BOARD - WOODEN WHITEBOARD / CORK

- IT**
- Design dall'aspetto fresco grazie alla cornice leggera in legno
 - Scrivi e fissa vari messaggi e note
 - Perfetta per il settore dell'accoglienza e degli uffici
- ES**
- Su aspecto y diseño es innovador gracias al marco de madera clara
 - Escribe y enganche varios mensajes o diferentes notas
 - Perfecto para el uso en la hostelería y en las oficinas
- FR**
- Design d'apparence agréable grâce au cadre en bois léger
 - Rédigez et épinglez plusieurs messages et notes
 - Parfait pour une utilisation dans le secteur de l'hospitalité et pour les bureaux



Art. nr.	DIN/Size	Dimensions (cm)			
		W	H	D	KG
WBC450x600LB	45 x 60	45	60	1,8	1,6
WBC600x900LB	60 x 90	60	90	1,8	2,6



See accessory page for options (p. 174)

Combi Board - Black Board / Cork (p. 172/ch. 11) and Black Letter Board (p. 118/ch. 7)

COMBI BOARD - BLACK BOARD / CORK

- IT**
- Design elegante grazie alla cornice in legno nero
 - Scrivi e fissa vari messaggi e note
 - Perfetta per il settore dell'accoglienza e degli uffici
- ES**
- Diseño elegante gracias al marco negro de madera
 - Escribe y enganche varios mensajes o diferentes notas
 - Perfecto para el uso en la hostelería y en las oficinas
- FR**
- Design élégant grâce au cadre en bois noir
 - Rédigez et épinglez plusieurs messages et notes
 - Parfait pour une utilisation dans le secteur de l'hospitalité et pour les bureaux

Art. nr.	DIN/Size	Dimensions (cm)			
		W	H	D	KG
WBBC450x600BL	45 x 60	45	60	1,8	1,6
WBBC600x900BL	60 x 90	60	90	1,8	2,6



SCRITTO® PINS

Accessory for all Pin Boards and cork Lockable Notice Boards



- IT** • Set di 100 pz. - adatto a bacheche in feltro o in sughero
- ES** • Contenido: 100 Uds. Para tablonos de corcho o fieltro
- FR** • Jeu de 100 pièces, daptées aux tableaux d'affichage en liège et en feutre

Art. nr. SETPINS

SCRITTO® SET OF PENS

Accessory for all Whiteboards, Glassboards and writable Lockable Notice Boards



- IT** • Un set di 4 penne; 1 colore nero, 1 blu, 1 verde e 1 rosso, per lavagne pulibili a secco
- ES** • Juego de 4 marcadores; 1x negro, 1x azul, 1x verde, 1x rojo
- FR** • Un jeu de 4 feutres : 1 noir, 1 bleu, 1 vert et 1 rouge, pour les tableaux effaçables à sec

Art. nr. SETFIXWB



SCRITTO® WHITEBOARD ERASER

Accessory for all Whiteboards, Glassboards and writable Lockable Notice Boards



- IT** • Cancellino a secco magnetico, adatto a lavagne e prodotti pulibili a secco
- ES** • Borrador magnético para borrado en seco, para pizarras blancas u otros productos de borrado en seco
- FR** • Tampon magnétique pour effacer à sec, convient aux tableaux blancs et aux produits effaçables à sec

Art. nr. WBERASER

SCRITTO® WHITEBOARD CLEANER

Accessory for all Whiteboards, Glassboards and writable Lockable Notice Boards



- IT** • Flacone liquido spray da 250 ml, adatto a lavagne con serratura e lavagne pulibili a secco
- ES** • Bote de spray líquido de 250 ml, para pizarras blancas con cerradura y pizarras de borrado en seco
- FR** • Flacon pulvérisateur de 250 ml, adapté aux tableaux blancs verrouillables et aux tableaux effaçables à sec

Art. nr. WBCLEANER

SCRITTO® STARTER KIT

Accessory for all Whiteboards, Glassboards and writable Lockable Notice Boards



- IT** • Set di pennarelli, gomma, detergente spray e magneti
- ES** • Set de marcadores, borrador, limpiador en spray e imanes
- FR** • Ensemble de marqueurs, gomme à effacer, spray nettoyant et aimants

Art. nr. STARTERKIT

SCRITTO® MAGNETS

Accessory for all magnetic Lockable Notice Boards and Whiteboards



- IT** • Set di 8 magneti, di diametro 20 mm o 35 mm. Disponibili in blu, rosso, bianco o nero
- ES** • Juego de 8 imanes, 20 mm o 35 mm en diámetro. Disponible en colores azul, rojo, blanco o negro
- FR** • Jeu de 8 aimants, diamètre de 20 mm ou 35 mm. Disponible en bleu, rouge, blanc ou noir

Art. nr. MAGNETS20BLUE
MAGNETS20RED
MAGNETS20WHITE
MAGNETS20BLACK
MAGNETS35BLUE
MAGNETS35RED
MAGNETS35WHITE
MAGNETS35BLACK



12. WAYFINDING SYSTEMS

Sistemi di orientamento
Sistemas de Orientación
Systèmes d'Orientation

Functional Wayfinding Systems that help guide people in the right direction. The portfolio consists of wall signage, barrier stands, belts and ropes for public guidance and managing queues. Ideal for airports, offices, hotels, museums and other public attractions.

INDEX

12.1 Wayfinding Systems **178**
Sistemi di orientamento
Sistemas de Orientación
Systèmes d'Orientation

12.2 Barriers **180**
Barriere
Barreras
Barrières

- QUICK AND EASY TO ASSEMBLE
- PORTABLE PRODUCT SO EASY TO TRANSPORT AND TO PLACE
- GREAT SOLUTION FOR EVERY SITUATION



✓ GOOD BARRIER FLEXI BELT POST ECONOMY

- Freestanding post with 3 sided belt clip and 2,5 m belt
- Ideal for queue guidance
- Great cost value ratio

👍 BETTER BARRIER FLEXI BELT POST

- 2,7 m retractable tensioned belt
- Heavy base plate with good stability
- Ideal for queue guidance

🏆 BEST BARRIER GOLD ROPE STAND

- Antique design
- Aluminium pole with heavy steel base
- 9 kg total weight for optimal stability

WALL MOUNTED SANDWICH PANEL

- IT**
- Elegante struttura a sandwich
 - Due facce da 3 mm in acrilico trasparente
 - Locandine nei formati da A5 fino ad A1
- ES**
- Construcción elegante tipo sándwich
 - 2 láminas de acrílico transparente de 3 mm
 - Tamaños de póster desde DIN A5 hasta A1
- FR**
- Élégante construction en sandwich
 - 2 feuilles d'acrylique transparent de 3 mm
 - Taille de poster A5 à A1



Art. nr.	DIN/Size	Dimensions (cm)			
		W	H	D	KG
FS25A4SET	A4	29	37,7	2,9	1,1
FS25A3SET	A3	37,7	50	2,9	1,8
FS25A2SET	A2	50	67,4	2,9	3,2
FS25A1SET	A1	67,4	92,1	2,9	5,5



WAYFINDING SYSTEM CURVED

- IT**
- Di facile utilizzo
 - Facile da installare
 - Disponibile un'ampia gamma di formati
- ES**
- Uso fácil
 - Instalación fácil
 - Disponible en amplia gama de tamaños
- FR**
- Facile à utiliser
 - Installation aisée
 - Large gamme de tailles disponible



Art. nr.	DIN/Size	Dimensions (cm)			
		W	H	D	KG
ISA6	A6	15,3	10,9	1,6	0,1
IS105x120	10,5 x 12	10,9	12,5	1,6	0,1
IS105x210	10,5 x 21	10,9	21,5	1,6	0,2
IS105x300	10,5 x 30	10,9	30,5	1,6	0,2
ISA5	A5	21,5	15,2	1,8	0,3
IS148x120	14,8 x 12	15,2	12,5	1,8	0,2
ISA4	A4	30,2	21,4	2,2	0,6
ISA3	A3	42,3	30,4	2,7	1,1

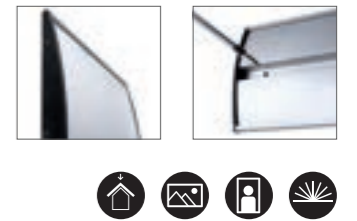

WAYFINDING SYSTEM SNAP

- IT**
- Facile da installare
 - Copertura antiriflesso
 - Cambio rapido delle grafiche
- ES**
- Fácil instalación
 - Folio protector antirreflejos
 - Cambio de gráfica rápido
- FR**
- Installation facile
 - Feuille antireflet
 - Changement rapide des visuels



Art. nr.	DIN/Size	Dimensions (cm)			
		W	H	D	KG
SS155X155	15,5 x 15,5	15,9	16,5	1,3	0,2
SSA6	A6	10,9	15,8	1,3	0,1
SSA5	A5	15,2	22	1,3	0,2
SSA4	A4	21,4	30,7	1,3	0,7



BARRIER FLEXI BELT POST

- IT**
 - Nastro estensibile da 2,7 m
 - Piastra di base pesante con una buona stabilità
 - Ideale per gestire le code
- ES**
 - Cinta tensada retráctil de 2,7 metros
 - Sólida base para buena estabilidad
 - Ideal para guiado de filas
- FR**
 - Courroie tendue rétractable de 2,7 m
 - Lourde plaque de base avec bonne stabilité
 - Idéale pour le guidage de file d'attente



Art. nr.	Dimensions (cm)		W	H	D	KG
	Pole	Belt				
BBBLACK	●	●	36	105	36	12,3
BBBLACKRED	●	●	36	105	36	11,5
BBCHROME	●	●	36	105	36	12,3
BBCHROMERED	●	●	36	105	36	11,5

Optional: Barrier Sign Holder (see p. 185)

BARRIER FLEXI BELT POST ECONOMY

- IT**
 - Montante autoportante con aggancio nastro su 3 lati e nastro da 2,5 m
 - Ideale per gestire le code
 - Ottimo rapporto qualità-prezzo
- ES**
 - Poste separador con clips de recepción en 3 lados y cinta tensada de 2,5 metros
 - Ideal para guiado de filas
 - Buena relación calidad-precio
- FR**
 - Pied indépendant avec clip de ceinture à 3 côtés et tapis de 2,5 m
 - Idéal pour le guidage de file d'attente
 - Excellent rapport qualité-prix



Art. nr.	Dimensions (cm)				
		W	H	D	KG
BBEBLACK	●	30	93,5	30	8,6
BBECHROME	●	30	93,5	30	8,6

Optional: Barrier Sign Holder (see p. 185)

BARRIER FLEXI BELT WALL MOUNTED

- IT**
 - Sistema di guida fissato al muro
 - Nastro estensibile da 3 m
 - 3 possibilità di aggancio per nastri flessibili
- ES**
 - Sistema de guiado de pared
 - Cinta flexible de 3 metros
 - 3 posibilidades de clip para la cinta flexible
- FR**
 - Système de guidage mural
 - Courroie flexible de 3 m
 - Possibilité de 3 clips pour courroies flexibles



Art. nr.	Dimensions (cm)				
		W	H	D	KG
BSWBBLACK	●	8	12	7,5	0,7
BSWSBLACK	●	8	12	7,5	0,7

BARRIER GOLD ROPE STAND

- IT**
 - Design antico
 - Colonnina in alluminio con solida base in acciaio
 - Peso totale di 9 kg per un'eccellente stabilità
- ES**
 - Diseño antiguo
 - Poste de aluminio con base sólida de acero
 - Peso total de 9 kg para óptima estabilidad
- FR**
 - Design antique
 - Poteau en aluminium avec base en acier lourd
 - Poids total de 9 kg pour une stabilité optimale



Art. nr.	Dimensions (cm)				
		W	H	D	KG
BSRGOLD	●	31	94	31	9,9

Optional: Barrier Gold Rope and Barrier Gold Wall Hook (see p. 185)

BARRIER CHROME ROPE STAND

- IT**
 - Design antico
 - Colonnina in alluminio con solida base in acciaio
 - Peso totale di 9 kg per un'eccellente stabilità
- ES**
 - Diseño antiguo
 - Poste de aluminio con base sólida de acero
 - Peso total de 9 kg para óptima estabilidad
- FR**
 - Design antique
 - Poteau en aluminium avec base en acier lourd
 - Poids total de 9 kg pour une stabilité optimale



Art. nr.	Dimensions (cm)				
		W	H	D	KG
BSRCHROME	●	31	98,7	31	9,9

Optional: Cafe Barrier Standard (p. 182), Barrier Chrome Rope and Barrier Chrome Wall Hook (see p. 185)

CAFE BARRIER STANDARD

- IT**
- Sistema segnapercorso e promozionale per uso interno
 - Facile collegamento tra le colonnine e il supporto
 - Aggiungi una grafica monofacciale o bifacciale per una strepitosa promozione
- ES**
- Sistema de guiado y promoción para interiores
 - Fácil conexión del poste a la base
 - Añada una gráfica a una o a doble cara para que su promoción sea increíble
- FR**
- Système de guidage et de promotion pour l'intérieur
 - Raccordement simple des poteaux au support
 - Possibilité d'ajouter un graphique à une ou à deux faces pour une promotion sensationnelle



Art. nr.	Pole	Dimensions (cm)			
		W	H	D	KG
CBSSET	●	201	98,7	31	11,7
Modular elements					
CBS	●	170	80	10	2,6
BSRCHROME	●	31	98,7	31	9,9



- CBSSET is 2 x BSRCHROME and 1 x CBS
- CBS is only the poles and rings
- Optional: Extend your promotion and connect multiple barriers together



CAFE BARRIER ECONOMY

- IT**
- Sistema segnapercorso e promozionale per uso interno
 - Estensione fino a 4 m per transenna
 - Puoi creare angoli con facilità
- ES**
- Sistema de guiado y promoción para el uso en interiores
 - Extensible hasta 4 metros por cada poste
 - Posibilidad de formar rincones fácilmente
- FR**
- Système de signalisation et de promotion pour l'intérieur
 - S'étend jusqu'à 4 m par barrière
 - Pour créer des recoins en toute simplicité



Art. nr.	Dimensions (cm)			
	W	H	D	KG
CBE	231	106	25	4,7
Modular elements				
CBE-EXT	206	106	25	2,6



- Optional: Extend your promotion and connect multiple barriers together (CBE-EXT)





ZIPPER-BARRIER

- IT** • Transenna segnapercorso interna per mostre, centri commerciali, luoghi pubblici e molto altro
- IT** • Sistema leggero con base solida e stabile
- IT** • Perfetta per opportunità promozionali eccezionali
- ES** • Postes separadores con cinta para ferias, centros comerciales, espacios públicos y mucho más
- ES** • Un sistema ligero con una base estable y pesada
- ES** • Perfecto para grandes oportunidades de publicidad
- FR** • Barrière anti-foule intérieure pour les expositions, les centres commerciaux, les espaces publics, etc.
- FR** • Un système léger avec une base stable et solide
- FR** • Idéal pour de grandes actions publicitaires

Art. nr.	Dimensions (cm)			
	W	H	D	KG
ZWBARRIER	206	107	36,2	4,8



- Tip! Connect multiple Zipper-Barrriers easily together thanks to special designed feet
- Included luxurious soft carry bag



BARRIER SIGN HOLDER

Accessory for Barrier Flexi Belt Post



- IT** • Espositore bifacciale A4 per attirare l'attenzione sulla transenna
- ES** • Tarjeta superior A4 de doble cara para llamar la atención
- FR** • Carte supérieure double face A4 pour attirer l'attention sur la barrière

Art. nr. BBBLACKSIGNA4 ●
BBCHROMESIGNA4 ●

BARRIER SIGN HOLDER

Accessory for Barrier Flexi Belt Post Economy



- IT** • Espositore bifacciale A4 per attirare l'attenzione sulla transenna
- ES** • Tarjeta superior A4 de doble cara para llamar la atención
- FR** • Carte supérieure double face A4 pour attirer l'attention sur la barrière

Art. nr. BBBLACKSIGNA4 ●
BBCHROMESIGNA4 ●

BARRIER GOLD ROPE

Accessory for Barrier Gold Rope Stand



- IT** • Cordone di velluto intrecciato o spazzolato premium
- ES** • Cuerda trenzada o de terciopelo de altísima calidad
- FR** • Corde de velours torsadée ou brossée de qualité supérieure

Art. nr. Twisted rope
BSRRPGLDBLACK ●
BSRRPGLDBRONZE ●

Brush velour rope
BSRRPGLDBLUE ●
BSRRPGLDRED ●

BARRIER CHROME ROPE

Accessory for Barrier Chrome Rope Stand



- IT** • Cordone di velluto intrecciato o spazzolato premium
- ES** • Cuerda trenzada o de terciopelo de altísima calidad
- FR** • Corde de velours torsadée ou brossée de qualité supérieure

Art. nr. Twisted rope
BSRRPCHRBLACK ●
BSRRPCHRBRONZE ●

Brush velour rope
BSRRPCHRBLUE ●
BSRRPCHRRED ●

BARRIER GOLD WALL HOOK

Accessory for Barrier Gold Rope Stand



- IT** • Soluzione conveniente per creare semplici percorsi pedonali
- ES** • Solución económica para señalar la dirección y el guiado
- FR** • Solution économique pour créer des parcours simples

Art. nr. BSRWHGOLD

BARRIER CHROME WALL HOOK

Accessory for Barrier Chrome Rope Stand



- IT** • Soluzione conveniente per creare semplici percorsi pedonali
- ES** • Solución económica para señalar la dirección y el guiado
- FR** • Solution économique pour créer des parcours simples

Art. nr. BSRWHCHROME

13. GLASS SHOWCASES

Bacheche di vetro
Vitrinas en vidrio
Vitrines en verre

Elegantly designed glass showcases are effective for putting valuables and collectables on display. Ideal for museums, offices, waiting rooms, retail stores and trade shows. Built from anodised aluminium profiles and glass elements. Available with lockable single and double glass doors as well as LED lighting options.

INDEX

13.1 Glass Showcases **188**
Bacheche di vetro
Vitrinas en vidrio
Vitrines en verre

- ✦ **TEMPERED GLASS FOR STABILITY**
- ✦ **SILVER AND BLACK FINISH, WIDE RANGE OF SIZES**
- ✦ **LED ILLUMINATED OPTIONS TO HIGHLIGHT EXPOSED ITEMS**

GLASS SHOWCASE 800 MM / 800 MM DOUBLE DOOR

- IT**
 - Struttura in alluminio con vetro temperato
 - 4 ripiani in vetro regolabili che possono sopportare fino a 10 kg
 - Anta doppia con serrature a cilindro
- ES**
 - Construcción de aluminio con cristal reforzado
 - 4 estantes de cristal que llegan a soportar hasta 10 kg
 - Doble puerta con bisagras y cerraduras cilíndricas
- FR**
 - Structure en aluminium avec verre trempé
 - 4 clayettes en verre réglables pouvant contenir jusqu'à 10 kg
 - Porte à charnières avec serrures à barillet



Art. nr.	Dimensions (cm)			
	W	H	D	KG
VR2-24-800	80	200	40	78,7
VR2-24-800F	80	200	40	79,2

Black colour available on request

GLASS SHOWCASE ILLUMINATED 400 MM

- IT**
 - Struttura in alluminio con vetro temperato
 - Lampade LED in cima alla vetrina in vetro
 - Anta battente con serrature a cilindro
- ES**
 - Construcción de aluminio con cristal reforzado
 - Lámparas LED en la parte superior de la vitrina
 - Puerta con bisagras y cerraduras cilíndricas
- FR**
 - Construction en aluminium avec verre trempé
 - Lampes à LED sur le dessus de la vitrine en verre
 - Porte à charnières avec serrures à barillet



Art. nr.	Dimensions (cm)			
	W	H	D	KG
VR2-24-400LED	40	200	40	53,5

Black colour available on request

GLASS SHOWCASE ILLUMINATED 800 MM / 800 MM DOUBLE DOOR

- IT**
 - Struttura in alluminio con vetro temperato
 - Lampade LED in cima alla vetrina in vetro
 - Anta doppia con serrature a cilindro
- ES**
 - Construcción de aluminio con cristal reforzado
 - Lámparas LED en la parte superior de la vitrina
 - Doble puerta con bisagras y cerraduras cilíndricas
- FR**
 - Construction en aluminium avec verre trempé
 - Lampes à LED sur le dessus de la vitrine en verre
 - Double porte avec serrures à barillet

Art. nr.	Dimensions (cm)			
	W	H	D	KG
VR2-24-800LED	80	200	40	79,4
VR2-24-800FLED	80	200	40	73

Black colour available on request



14. BROCHURE HOLDERS

Porta documenti Portafolletos Porte-brochures

Brochure Holders are designed to keep promotional materials and literature well organised and visible to the public. A wide range of designs and sizes for catalogues, leaflets, magazines, business cards and other literature.

- ALL POPULAR SIZES POSSIBLE, FROM BUSINESS CARDS TO CATALOGUES
- EASY TO USE AND TRANSPORT
- SILVER, BLACK OR WHITE FINISHES TO FIT EVERY ENVIROMENT

INDEX

- | | |
|---|-----|
| 14.1 Scritto® Brochure Holders
<i>Porta documenti Scritto®
Scritto® Portafolletos
Scritto® Porte-brochures</i> | 192 |
| 14.2 Taymar® Brochure Holders
<i>Porta documenti Taymar®
Taymar® Portafolletos
Taymar® Porte-brochures</i> | 193 |
| 14.3 Business Card Holders
<i>Porta biglietti da visita
Portafolletos Tarjetas de
Visita
Porte-Cartes de Visite</i> | 196 |
| 14.4 Outdoor Leaflet Holders
<i>Porta biglietti da visita per
uso esterno
Portafolletos para Exteriores
Porte-brochures pour
Extérieur</i> | 197 |
| 14.5 Name Badges and Brochure Holder Magnetic
<i>Portanomi e portadocumenti
magnetici
Porta Nombres y
Portafolletos Magnético
Badges Nominatifs et
Portebrochures
Magnétique</i> | 198 |

14.1 SCRITTO® BROCHURE HOLDERS

DA4P

BESTSELLER

2DA4P

3DA4P

4DA4P

BESTSELLER



- IT** • Ripiano e fissaggio al muro
ES • Posibilidad de poner en mostrador o en pared
FR • Montage sur comptoir et mural

- IT** • Ripiano e fissaggio al muro
ES • Posibilidad de poner en mostrador o en pared
FR • Montage sur comptoir et mural

Art. nr.	Pocket depth (cm)	DIN/Size	Dimensions (cm)		
			W	H	D
DA4P	6,4	1 x A4	22,4	26,6	9,4
2DA4P	2,9	2 x A4	22,4	26,6	9,4

Art. nr.	Pocket depth (cm)	DIN/Size	Dimensions (cm)		
			W	H	D
3DA4P	3,1	3 x A4	22,4	25,9	12,1
4DA4P	3	4 x A4	22,4	29,9	19

DA5P

BESTSELLER

4DA5P

BESTSELLER

D13A4P

BESTSELLER

4D13A4P

BESTSELLER



- IT** • Ripiano e fissaggio al muro
ES • Posibilidad de poner en mostrador o en pared
FR • Montage sur comptoir et mural

- IT** • Ripiano e fissaggio al muro
ES • Posibilidad de poner en mostrador o en pared
FR • Montage sur comptoir et mural

Art. nr.	Pocket depth (cm)	DIN/Size	Dimensions (cm)		
			W	H	D
DA5P	5,3	1 x A5	15,7	20,8	7,4
4DA5P	2,5	4 x A5	15,7	25,5	15,8

Art. nr.	Pocket depth (cm)	DIN/Size	Dimensions (cm)		
			W	H	D
D13A4P	4,8	1 x 1/3 A4	10,8	20,9	6,5
4D13A4P	2,5	4 x 1/3 A4	10,8	25,5	15,8

PWA4P



- IT** • Fissaggio al muro
ES • Montaje en la pared
FR • Montage mural

Art. nr.	DIN/Size	Dimensions (cm)		
		W	H	D
PWA5P	A5	18,7	18,5	6,7
PWA4P	A4	27	25,5	9,4

14.2 TAYMAR® BROCHURE HOLDERS

W330

C330

W230X

W230



- IT** • Fissaggio al muro (W330), ripiano e fissaggio al muro (C330)
ES • Montaje en la pared (W330), posibilidad de poner en mostrador o en pared (C330)
FR • Montage mural (W330), montage sur comptoir et mural (C330)

- IT** • Fissaggio al muro (W230X), ripiano e fissaggio al muro (C330)
ES • Montaje en la pared (W230X), posibilidad de poner en mostrador o en pared (W230)
FR • Montage mural (W230X), montage sur comptoir et mural (W230)

Art. nr.	Pocket depth (cm)	DIN/Size	Dimensions (cm)		
			W	H	D
W330	3,2	1 x A4	34	18,6	3,8
C330	3,2	1 x A4	34	18,6	7,8

Art. nr.	Pocket depth (cm)	DIN/Size	Dimensions (cm)		
			W	H	D
W230X	3,2	1 x A4	24	25	4
W230	3,2	1 x A4	24	25	4

C230

BESTSELLER

2C230X

3W230



- IT** • Ripiano (C230), ripiano e fissaggio al muro (2C230X), Fissaggio al muro (3W230)
ES • Para mostrador (C230), posibilidad de poner en mostrador o en pared (2C230X), montaje en la pared (3W230)
FR • Comptoir (C230), montage sur comptoir et mural (2C230X), montage mural (3W230)

Art. nr.	Pocket depth (cm)	DIN/Size	Dimensions (cm)		
			W	H	D
C230	3,2	1 x A4	23,3	24,9	8,5
2C230X	3,2	2 x A4	23,7	28,5	12,4

Art. nr.	Pocket depth (cm)	DIN/Size	Dimensions (cm)		
			W	H	D
3W230	3,2	3 x A4	23,7	53,5	10,2

3C230

4C230X

BESTSELLER

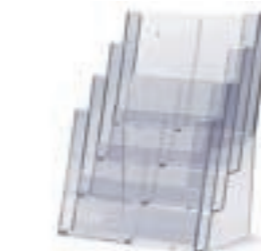

- IT** • Ripiano (3C230), ripiano e fissaggio al muro (4C230X)
ES • Para mostrador (3C230), posibilidad de poner en mostrador o en pared (4C230X)
FR • Comptoir (3C230), montage sur comptoir et mural (4C230X)

Art. nr.	Pocket depth (cm)	DIN/Size	Dimensions (cm)		
			W	H	D
3C230	3,2	3x A4	23,7	33,9	15,5
4C230X	3,2	4x A4	23,6	34	17,5

W160



- IT • Ripiano e fissaggio al muro
- ES • Posibilidad de poner en mostrador o en pared
- FR • Montage sur comptoir et mural

Art. nr.	Pocket depth (cm)	DIN/Size	Dimensions (cm)		
			W	H	D
W160	3,2	1x A5	16,5	19,1	3,5

WLA5



C160

BESTSELLER



- IT • Fissaggio al muro (WLA5), Ripiano (C160)
- ES • Wandmontage (WLA5), obere Theke (C160)
- FR • Wandmontage (WLA5), balie presentatie (C160)

Art. nr.	Pocket depth (cm)	DIN/Size	Dimensions (cm)			
			W	H	D	
WLA5	3,2	1x A5	23,5	13,5	3,5	84
C160	3,2	1x A5	16,5	21,4	7,5	80

C110

BESTSELLER



2C112



W110X



W110



- IT • Ripiano (C110, 2C112), Fissaggio al muro (W110X), ripiano e fissaggio al muro (W110)
- ES • Posibilidad de poner en mostrador (C110, 2C112), o en pared (W110X), de poner en mostrador o en pared (W110)
- FR • Montage sur comptoir (C110, 2C112), mural (W110X), sur comptoir et mural (W110)

Art. nr.	Pocket depth (cm)	DIN/Size	Dimensions (cm)			Art. nr.	Pocket depth (cm)	DIN/Size	Dimensions (cm)		
			W	H	D				W	H	D
C110	3,2	1x DL	11,4	18,1	6,5	W110X	3,2	1x DL	11,5	15	4
2C112	3,2	2x DL	23,3	24,9	8,5	W110	3,2	1x DL	11,5	15	4

2C160



3C160



4C160

BESTSELLER

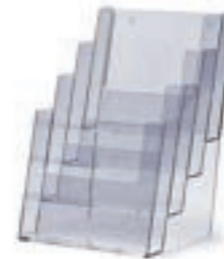

- IT • Ripiano e fissaggio al muro
- ES • Posibilidad de poner en mostrador o en pared
- FR • Montage sur comptoir et mural

Art. nr.	Pocket depth (cm)	DIN/Size	Dimensions (cm)		
			W	H	D
2C160	3,2	2x A5	16,4	24,9	11,8
3C160	3,2	3x A5	16,6	21,8	11

Art. nr.	Pocket depth (cm)	DIN/Size	Dimensions (cm)		
			W	H	D
4C160	3,2	4x A5	16,6	25,6	15,5

2C230



4C230



4C330



- IT • Ripiano e fissaggio al muro
- DE • Posibilidad de poner en mostrador o en pared
- FR • Montage sur comptoir et mural

Art. nr.	Pocket depth (cm)	DIN/Size	Dimensions (cm)		
			W	H	D
2C230	3,2	4x DL	23,7	28,5	12,4
4C230	3,2	8x DL	23,6	34	17,5

Art. nr.	Pocket depth (cm)	DIN/Size	Dimensions (cm)		
			W	H	D
4C330	3,2	12x DL	34	34,5	17,5

3C104



- IT • Ripiano e fissaggio al muro
- ES • Posibilidad de poner en mostrador o en pared
- FR • Montage sur comptoir et mural

Art. nr.	Pocket depth (cm)	DIN/Size	Dimensions (cm)		
			W	H	D
3C104	3,2	3x 1/3 A4	10,9	21,8	11,2

2C110



4C110

BESTSELLER



- IT • Ripiano
- ES • Para mostrador
- FR • Comptoir

Art. nr.	Pocket depth (cm)	DIN/Size	Dimensions (cm)		
			W	H	D
2C110	3,2	2x DL	11,5	27	12
4C110	3,2	4x DL	11,5	25,5	15

3W110H



4W104



WPA6



- IT • Fissaggio al muro (3W110H), ripiano e fissaggio al muro (4W104)
- DE • Montaje en la pared (3W110H), de poner en mostrador o en pared (4W104)
- FR • Montage mural (3W110H), sur comptoir et mural (4W104)

Art. nr.	Pocket depth (cm)	DIN/Size	Dimensions (cm)		
			W	H	D
3W110H	3,2	3x DL	34	18,6	3,8
4W104	3,2	4x 1/3 A4	42,5	15	6,5

- IT • Ripiano e fissaggio al muro
- ES • Posibilidad de poner en mostrador o en pared
- FR • Montage sur comptoir et mural

Art. nr.	Pocket depth (cm)	DIN/Size	Dimensions (cm)		
			W	H	D
WPA6	3,2	1x A6	11,5	12	3,8

14.3 BUSINESS CARD HOLDERS

WBC93

VCR92

BESTSELLER

BC93

BESTSELLER

VBC56



- IT** • Fissaggio al muro (WBC93), Ripiano (VCR92)
ES • Montaje en la pared (WBC93), para mostrador (VCR92)
FR • Montage mural (WBC93), comptoir (VCR92)

- IT** • Ripiano
ES • Para mostrador
FR • Comptoir

Art. nr.	Pocket depth (cm)	DIN/Size	Dimensions (cm)		
			W	H	D
WBC93	1,8	9,3 x 5	10,1	3,7	2,3
VCR92	1,8	9,3 x 5	9,6	4,3	2,8

Art. nr.	Pocket depth (cm)	DIN/Size	Dimensions (cm)		
			W	H	D
BC93	1,7	9,3 x 5	10,2	5,3	3,8
VBC56	1,7	5 x 9,3	6,3	7,1	3,7

4BC93

4VCS95

8BC93

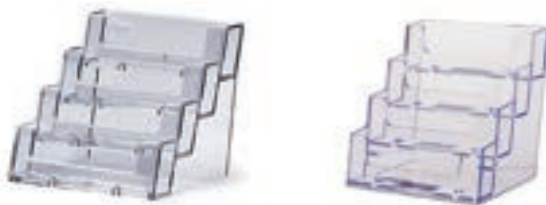

- IT** • Ripiano
ES • Para mostrador
FR • Comptoir

- IT** • Ripiano
ES • Para mostrador
FR • Comptoir

Art. nr.	Pocket depth (cm)	DIN/Size	Dimensions (cm)		
			W	H	D
4BC93	1,7	4x (9,3 x 5)	10	9	10
4VCS95	1,7	4x (9,3 x 5)	9,9	10,1	8,6

Art. nr.	Pocket depth (cm)	DIN/Size	Dimensions (cm)		
			W	H	D
8BC93	1,7	8x (9,3 x 5)	19,7	10	9

14.4 OUTDOOR LEAFLET HOLDERS

OD95



- IT** • Resistente alle intemperie (antispruzzo) e polistirolo trasparente
ES • Resistente a la intemperie (a prueba de salpicaduras) y de poliestireno transparente
FR • Résistant aux intempéries (éclaboussures) et polystyrène

Art. nr.	DIN/Size	Dimensions (cm)		
		W	H	D
OD95	1 x 9,3 x 5	10,6	6,2	3,2

OD110



- IT** • Resistente alle intemperie (antispruzzo) e polistirolo trasparente
ES • Resistente a la intemperie (a prueba de salpicaduras) y de poliestireno transparente
FR • Résistant aux intempéries (éclaboussures) et polystyrène

Art. nr.	DIN/Size	Dimensions (cm)		
		W	H	D
OD110	1x DL	11,3	22,7	3,4

OD160



- IT** • Resistente alle intemperie (antispruzzo) e polistirolo trasparente
ES • Resistente a la intemperie (a prueba de salpicaduras) y de poliestireno transparente
FR • Résistant aux intempéries (éclaboussures) et polystyrène

Art. nr.	DIN/Size	Dimensions (cm)		
		W	H	D
OD160	1x A5	16,5	22,7	4,4

OD230



- IT** • Resistente alle intemperie (antispruzzo) e polistirolo trasparente
ES • Resistente a la intemperie (a prueba de salpicaduras) y de poliestireno transparente
FR • Résistant aux intempéries (éclaboussures) et polystyrène

Art. nr.	DIN/Size	Dimensions (cm)		
		W	H	D
OD230	1x A4	24	32	4,8

NB70SSM



- IT • Design argento piatto magnetico
- ES • Diseño plano de imán plateado
- FR • Conception magnétique plate argentée

Art. nr. DIN/Size Dimensions (cm)

		W	H	D
NB70SSM	□ 6,4 x 1,3	7	3,4	1

NB65S



- IT • Design piatto con chiusura e perno di sicurezza
- ES • Diseño plano con un clip e imperdible
- FR • Conception plate avec clip et goupille de sécurité

Art. nr. DIN/Size Dimensions (cm)

		W	H	D
NB65S	□ 6,5 x 3,1	6,5	3,5	1

BHMA5



- IT • Adatto a tutti i Porta Banner Roll Up, Porta Banner e Pareti in tessuto
- ES • Adecuado para Roll-Ups, Banners y las paredes textiles
- FR • Convient aux Roll-up, aux Banner Stands et murs Textiles

Art. nr. DIN/Size Dimensions (cm)

		W	H	D
BHMA5	A5	16,5	20,5	1,5



PROMOTIONS AND EVENTS

Promozioni ed eventi
Promociones y Eventos
Promotions et événements



All eyes on your brand, promotion or presentation with our promotional displays. Various sizes, graphics, designs and options to be the perfect fit for every product presentation, exhibition or event.

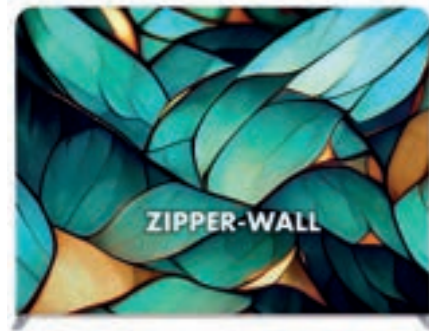

ZIPPER-WALL STRAIGHT BASIC
See 18. Walls
Page 270



COUNTER EASY OVAL
See 17. Counters and Table Covers
Page 253



DIGITAL COUNTER FUTURO
See 17. Counters and Table Covers
Page 246

BEACH FLAG ALU WIND & PADDLE
See 16. Flags
Page 238



NEW

ZIG ZAG BROCHURE STAND FOLDABLE
See 6. Leaflet and Catalogue Holders
Page 104



COUNTER IMPRESS
See 17. Counters and Table Covers
Page 256

POP-UP IMPRESS STRAIGHT
See 18. Walls
Page 264



ZIPPER-BARRIER
See 12. Wayfinding Systems
Page 184



DIGITAL A-BOARD SPECTRUM
See 4. Digital Displays
Page 74



ZIPPER-BANNER SLIM
See 15. Banners
Page 220



ZIPPER-BANNER TRIANGLE
See 15. Banners
Page 224

A-BOARD FABRIC MOVE
See 5. Pavement Signs
Page 88



BRIGHTBOX XL
See 18. Walls
Page 262



BRIGHTBOX DOUBLE
See 3. Illuminated Displays
Page 58



TENT STEEL
See 19. Tents
Page 280

interesting categories for you

3. ILLUMINATED DISPLAYS	48
4. DIGITAL DISPLAYS	62
6. LEAFLET AND CATALOGUE HOLDERS	96
12. WAYFINDING SYSTEMS	176
15. BANNERS	202
16. FLAGS	230
17. COUNTERS AND TABLE COVERS	244
18. WALLS	260
19. TENTS	278

15. BANNERS

Porta banners Banners Banners

Banners are the most popular, versatile and widely used mobile displays in the world. Designed for quick, easy and effective promotional use. Perfect for a variety of settings, from trade shows to shopping malls, airports to restaurants. Available for indoor and outdoor use, in a wide range of styles and sizes to meet any budget. Packaged in a convenient travel case.

- QUICK AND EASY CHANGE OF GRAPHICS
- GRAPHIC AVAILABLE TO CUSTOMISE YOUR BANNER
- DURABLE AND ELEGANT

INDEX

15.1 Roll-Banners	204
<i>Roll-Banners</i>	
<i>Roll-Banners</i>	
<i>Roll-Banners</i>	
15.2 Bannerstands	214
<i>Porta banners</i>	
<i>Banner</i>	
<i>Supports pour Bannières</i>	
15.3 Hanging Banners	226
<i>Porta banners a sospensione</i>	
<i>Banners Colgantes</i>	
<i>Banners Suspendues</i>	
15.4 Accessories	228
<i>Accessori</i>	
<i>Accesorios</i>	
<i>Accessoires</i>	



GOOD ROLL-BANNER BASIC

- Extremely reliable
- Height adjustable with optional extension pole
- Affordable banner for promotional or project use

BETTER ROLL-BANNER DELUXE

- Extremely durable banner with an elegant finish
- Roll-Banner with easy graphic exchange
- Height adjustable

BEST ZIPPER-BANNER SLIM

- Great alternative for the standard Roll-Banner
- Single-sided or double-sided wrinkle-free fabric cover
- Easy-to-assemble click system

SELECTION TABLE

	Colour	Page	Side view	Width	Height	KG	Single-sided (S) or double-sided (D) print	Number of poles	Telescopic pole	Height indication on pole	Adhesive on bottom	Snap profile on bottom	Number of feet	Foot type	Top profile type	Bag type	
Budget	●●○	204		80	200	1,8	S	1			x		2	F3	P2	B1	
				85	200	1,9		1		x				2	F3	P2	B1
				100	200	2,1		1		x				2	F3	P2	B1
Challenger Alu	●●○	205		80	200	2	S	1			x		2	F2	P1	B3	
				85	200	2,1		1		x				2	F2	P1	B3
				100	200	2,3		1		x				2	F2	P1	B3
Challenger Next	●●●○	205		80	200	2	S	1			x		2	F3	P1	B3	
				85	200	2,1		1		x				2	F3	P1	B3
				100	200	2,3		1		x				2	F3	P1	B3
Challenger Black	●●●●	205		85	200	2,1	S	1			x		2	F2	P1	B3	
				100	200	2,3		1		x				2	F2	P1	B3
Basic 1 foot	●●○	205		60	200	2,3	S	1			x		1	F2	P2	B4	
				85	200	2,8		1		x				1	F2	P2	B4
				100	200	3,2		1		x				1	F2	P2	B4
Basic 2 feet	●●●○	205		80	200	2,8	S	1			x		2	F2	P2	B4	
				85	200	2,8		1		x				2	F2	P2	B4
				100	200	3,2		1		x				2	F2	P2	B4
				120	200	3,9		2		x				2	F2	P2	B4
				150	200	4		2		x				2	F2	P2	B4
Basic Black	●●●●	205		85	200	2,8	S	1			x		2	F2	P2	B4	
				100	200	3,2		1		x				2	F2	P2	B4
Plus	●●●○	206		60	200	2,2	S	1			x		2	F3	P2	B2	
				80	200	2,2		1		x				2	F3	P2	B2
				85	200	2,8		1		x				2	F3	P2	B2
				100	200	3,2		1		x				2	F3	P2	B2
				120	200	4,1		2		x				2	F3	P2	B2
				150	200	4,8		2		x				2	F3	P2	B2
Triangle	●●○	206		85	160-220	3,5	S	1	x		x		1	F4	P2	B4	
				100	160-220	3,8		1	x		x		1	F4	P2	B4	
				120	160-220	5,2		2	x		x		2	F4	P2	B4	
				150	160-220	6,1		2	x		x		2	F4	P2	B4	
Evolution	●●●○	207		85	160-220	3,6	S	1	x		x		1	F5	P3	B4	
				100	160-220	4,1		1	x		x		1	F5	P3	B4	
				120	160-220	4,9		1	x		x		2	F5	P3	B4	
				150	160-220	6		2	x		x		2	F5	P3	B4	
Premium	●●○	208		85	160-220	5,7	S	1	x		x		0		P3	B5	
				100	160-220	6,8		1	x		x		0		P3	B5	
				120	160-220	8,3		1	x		x		0		P3	B5	
				150	160-220	10		2	x		x		0		P3	B5	
Premium Black	●●●●	208		85	160-220	5,7	S	1	x		x		0		P3	B5	
				100	160-220	6,8		1	x		x		0		P3	B5	
Massive	●●○	208		85	160-220	4,1	S	1	x		x		1	F6	P3	B4	
				100	160-220	5		1	x		x		1	F6	P3	B4	
Premium Clamp	●○	209		85	160 - 225	5,5	S	1	x		x		0		P3	B5	
				100	160 - 225	5,7		1	x		x		0		P3	B5	
Deluxe	●○	209		85	160 - 225	5,3	S	1	x	x			0		P3	B5	
				100	160 - 225	6		1	x	x			0		P3	B5	
Twin	●○	210		85	200	4,6	D	1			x	x	0		P1	B5	
				100	200	5,2		1			x	x	0		P1	B5	
Double	●○	210		85	200	6,6	D	1			x		0		P3	B5	
				100	200	7,6		1			x		0		P3	B5	
Extreme	●○	211		150	170-270	9,8	S	2	x	x	x		2	F4	P4	B4	
				200	170-300	11,6		2	x	x	x		2	F4	P4	B4	

Foot type F2

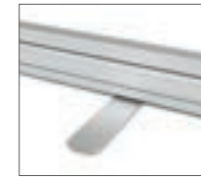

Foot type F3



Foot type F4

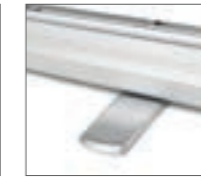

Foot type F5



Foot type F6



Top profile type P1



Top profile type P2



Top profile type P3



Top profile type P4



Bag type B1



Bag type B2



Bag type B3



Bag type B4



Bag type B5



More information about the printing options, see page 288 & 289

ROLL-BANNER BUDGET

- IT**
 - Cassetta leggera
 - Ottimo rapporto qualità-prezzo
 - Adatto per un uso promozionale o di progetto
- ES**
 - Base ligera
 - Excelente relación calidad-precio
 - Adecuado para uso promocional o de proyectos
- FR**
 - Casette légère
 - Excellent rapport qualité/prix
 - Adapté à un usage promotionnel ou à un projet



BESTSELLER

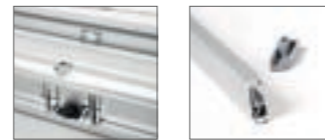

Art. nr.	Dimensions (cm)		
	W	H	KG
RBB080	80	200	1,8
RBB085	85	200	1,9
RBB100	100	200	2,1

ROLL-BANNER CHALLENGER

- IT**
 - Aspetto leggero ed elegante
 - Disponibile in 3 colori
 - Ideale per i più svariati eventi indoor
- ES**
 - Aspecto ligero y elegante
 - Disponible en 3 variaciones de color
 - Ideal para los eventos de interior más diversos
- FR**
 - Look léger et élégant
 - Disponible en 3 coloris
 - Idéal pour la plupart des événements en intérieur



alu



Art. nr.		Dimensions (cm)		
		W	H	KG
Alu				
RBCHA080	●	80	200	2
RBCHA085	●	85	200	2,1
RBCHA100	●	100	200	2,3
Next				
RBCHN080	●●	80	200	2
RBCHN085	●●	85	200	2,1
RBCHN100	●●	100	200	2,3
Black				
RBCHB080	●	80	200	2
RBCHB085	●	85	200	2,1
RBCHB100	●	100	200	2,3

ROLL-BANNER BASIC

- IT**
 - Estremamente affidabile
 - Altezza regolabile con palo di prolunga opzionale
 - Banner accessibile per un uso promozionale o di progetto
- ES**
 - Extremadamente confiable
 - Altura ajustable con poste de extensión opcional
 - Banner económico para uso promocional o de proyectos
- FR**
 - Extrêmement fiable
 - Hauteur réglable avec un mât optionnel
 - Bannière abordable pour une utilisation promotionnelle ou basée sur un projet



Art. nr.		Feet	Dimensions (cm)		
			W	H	KG
RBBAS1F060	●	1	60	200	2,3
RBBAS1F085	●	1	85	200	2,8
RBBAS1F100	●	1	100	200	3,2
RBBAS2F080	●	2	80	200	2,8
RBBAS2F085	●	2	85	200	2,8
RBBAS2F100	●	2	100	200	3,2
RBBAS2F120	●	2	120	200	3,9
RBBAS2F150	●	2	150	200	4
RBBASB085	●	2	85	200	2,8
RBBASB100	●	2	100	200	3,2

➤ **Optional: Lengthening Pole (+ 20 cm height) in silver and black see p. 228**

➤ **Available in 3 types of graphic materials (see p. 288 - 289)**

➤ **See accessories page for options (p. 228)**



ROLL-BANNER PLUS

- IT**
 - Solido, elegante e affidabile
 - I tappini neri sui piedini evitano danni alla superficie
 - Cassetta solida e pesante
- ES**
 - Robusto, fiable y elegante
 - Casquillos negros en los pies de evitar daños a la superficie
 - Base sólida y resistente
- FR**
 - Stable, élégant et fiable
 - Les embouts noirs sur les pieds empêchent d'endommager la surface
 - Lourde cassette solide



Art. nr.	Dimensions (cm)		
	W	H	KG
RBPL060	60	200	2,2
RBPL080	80	200	2,2
RBPL085	85	200	2,8
RBPL100	100	200	3,2
RBPL120	120	200	4,1
RBPL150	150	200	4,8

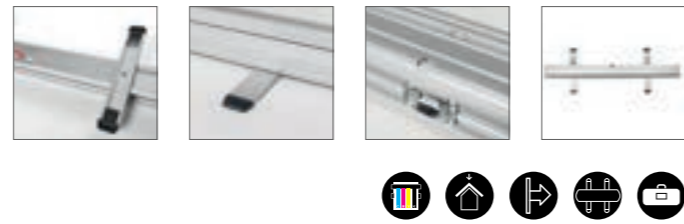

ROLL-BANNER EVOLUTION

- IT**
 - Aspetto elegante e alla moda
 - Altezza regolabile
 - Vano aggiuntivo per alloggiamento del palo nella custodia
- ES**
 - Aspecto elegante y con estilo
 - Altura ajustable
 - Compartimento de almacenamiento adicional para la bolsa
- FR**
 - Un look élégant et stylé
 - Réglable en hauteur
 - Sac avec rangement supplémentaire pour le mât

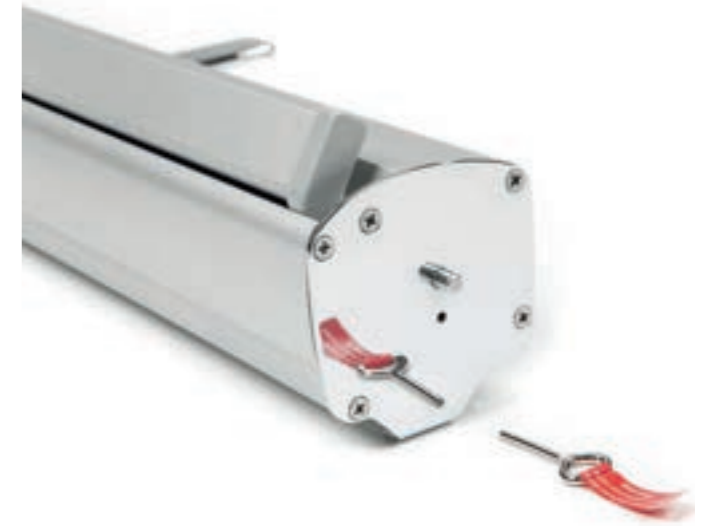

Art. nr.	Feet	Dimensions (cm)		
		W	H	KG
RBEVO085	1	85	160-220	3,6
RBEVO100	1	100	160-220	4,1
RBEVO120	2	120	160-220	4,9
RBEVO150	2	150	160-220	6



Roll-Banner Open-Air (p. 213/ch. 15) and Window Snap Frame (p. 19/ch. 1)

ROLL-BANNER TRIANGLE

- IT**
 - Forma che risalta e stabilità eccellente
 - Piedino estraibile con cuscinetti antiscivolo e clip di chiusura
 - Altezza regolabile
- ES**
 - Soporte a la última y con una excelente estabilidad
 - Pies con almohadillas antideslizantes y clip de fijación
 - Altura ajustable
- FR**
 - Forme remarquable et excellente stabilité
 - Pied pivotant avec coussinets antidérapants et clip de blocage
 - Réglable en hauteur



Art. nr.	Feet	Dimensions (cm)		
		W	H	KG
RBTR085	1	85	160-220	3,5
RBTR100	1	100	160-220	3,8
RBTR120	2	120	160-220	5,2
RBTR150	2	150	160-220	6,1



ROLL-BANNER PREMIUM

- IT**
 - Cassetta elegante con tappi laterali cromati
 - Aspetto esclusivo
 - Altezza regolabile
- ES**
 - Base elegante con tapas laterales cromadas
 - Apariencia exclusiva
 - Altura ajustable
- FR**
 - Cassette élégante avec caches chromés
 - Apparence exclusive
 - Hauteur réglable



Art. nr.	Ø	Dimensions (cm)		
		W	H	KG
RBP085	●	85	160-220	5,7
RBP100	●	100	160-220	6,8
RBP120	●	120	160-220	8,3
RBP150	●	150	160-220	10
RBPB085	●	85	160-220	5,7
RBPB100	●	100	160-220	6,8

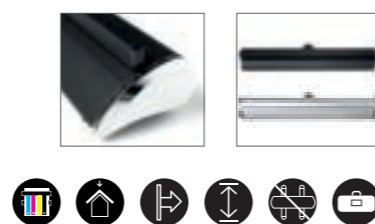

ROLL-BANNER PREMIUM CLAMP

- IT**
 - Possibilità di cambiare grafica facilmente
 - Altezza regolabile
 - Cassetta elegante con tappi laterali a forma di goccia
- ES**
 - Facilita todavía más el cambio de gráfica
 - Altura ajustable
 - La base elegante con tapas laterales en forma de lágrima
- FR**
 - Possibilité de changer facilement le graphique
 - Hauteur réglable
 - Cassette élégante avec embouts latéraux en forme de goutte d'eau



Art. nr.	Dimensions (cm)		
	W	H	KG
RBPC085	85	160-225	5,5
RBPC100	100	160-225	5,7



• Optional: Extra aluminium strip for new graphic (see p. 228)

ROLL-BANNER MASSIVE

- IT**
 - Piedini in alluminio massiccio
 - Altezza regolabile
 - Solido, robusto e di estrema durata
- ES**
 - Pies de aluminio macizo
 - Altura ajustable
 - Fuerte, robusto y muy duradero
- FR**
 - Pieds massifs en aluminium
 - Hauteur réglable
 - Solide, résistant et extrêmement durable



Art. nr.	Feet	Dimensions (cm)		
		W	H	KG
RBMAS085	1	85	160-220	4,1
RBMAS100	1	100	160-220	5



• See accessories page for options (p. 228)

ROLL-BANNER DELUXE

- IT**
 - Banner di durata estrema con finitura elegante
 - Porta Banner Roll Up con facile sostituzione della grafica
 - Altezza regolabile
- ES**
 - Banner extremadamente duradero con un acabado elegante
 - Banner enrollable con fácil cambio de gráfica
 - Altura ajustable
- FR**
 - Bannière extrêmement durable avec une finition élégante
 - Roll-Banner avec changement simple du visuel
 - Hauteur réglable



Art. nr.	Dimensions (cm)		
	W	H	KG
RBL085	85	160-225	5,3
RBL100	100	160-225	6

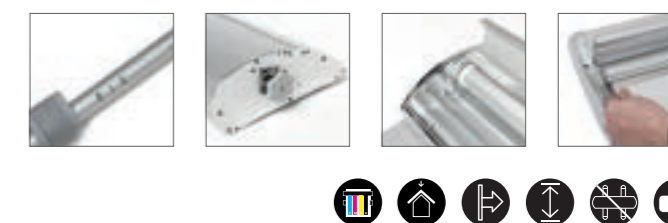

• Optional: Extra aluminium strip for new graphic (see p. 228)

• Available in 3 types of graphic materials (see p. 288 - 289)

• See accessories page for options (p. 228)

ROLL-BANNER TWIN

- IT**
 - Banner bifacciale
 - Il palo è invisibile tra le due grafiche
 - Vano aggiuntivo per alloggiamento del palo nella custodia
- ES**
 - Banner de doble cara
 - Poste invisible entre las dos impresiones
 - Compartimiento extra de almacenamiento para el poste en la bolsa
- FR**
 - Bannière double-face
 - Le mât est invisible entre deux visuels
 - Compartiment supplémentaire pour le rangement des mâts dans le sac



Art. nr.	Dimensions (cm)			KG
	W	H		
RBTW085	85	200		4,6
RBTW100	100	200		5,2

ROLL-BANNER EXTREME

- IT**
 - Cassetta ampia e alta
 - Stabile, fisso ed estremamente robusto
 - Altezza regolabile
- ES**
 - Base ancha
 - Estable, firme y extremadamente robusto
 - Altura ajustable
- FR**
 - Grande et lourde cassette
 - Stable, ferme et extrêmement robuste
 - Réglable en hauteur



Art. nr.	Dimensions (cm)			KG
	W	H		
RBEX150	150	170-270		9,8
RBEX200	200	170-300		11,6

- Available in 1 type of graphic material (see p. 288 - 289)
- Graphic material Symbio Banner

ROLL-BANNER DOUBLE

- IT**
 - Banner bifacciale professionale prestigioso
 - Estremamente stabile grazie all'ampia cassetta pesante
 - Sta completamente in posizione verticale
- ES**
 - Banner de doble cara de lujo y profesional
 - Extremadamente estable debido a la fuerte y amplia base
 - Se mantiene completamente erguido
- FR**
 - Bannière professionnelle de luxe double-face
 - Extrêmement stable grâce à la large et lourde cassette
 - Se tient complètement droit

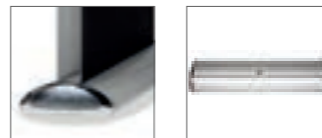

Art. nr.	Dimensions (cm)			KG
	W	H		
RBD085	85	200		6,6
RBD100	100	200		7,6

ROLL-BANNER OPEN-AIR

- IT**
 - Banner bifacciale per uso esterno
 - Sicuro e stabile
 - Cassetta in alluminio pesante
- ES**
 - Baner doble cara para uso en exteriores
 - Seguro y estable
 - Base de aluminio resistente
- FR**
 - Bannière double-face pour utilisation en extérieur
 - Sécurisée et stable
 - Casette en aluminium pour utilisation intensive



Art. nr.	Dimensions (cm)			KG
	W	H		
RBOA085	85	200		9,1

- Available in 2 types of graphic material (see p. 288 - 289)
- Graphic material Symbio Banner

BANNER OUTDOOR

- IT**
 - Regolabile in altezza con clip in alluminio
 - Supporto banner in vetroresina
 - Cambio grafica semplice e veloce
- ES**
 - Ajustable en altura con clip de aluminio
 - Soporte de banner de fibra de vidrio
 - Impresión rápida y fácil de cambiar
- FR**
 - Hauteur réglable avec clip en aluminium
 - Porte-baneroles en fibre de verre
 - Changement rapide et facile du visuel



Art. nr.	Dimensions (cm)		
	W	H	KG
OB180	80	180	4

Graphic available

Roll-Banner Challenger (p. 207/ch. 15), Postersnapper (p. 22/ch. 1), Micro Flag (p. 232/ch. 16), Natura Table Top Chalk Board (p. 120/ch. 7)



L-BANNER QUICK

- IT**
 - Un'alternativa elegante ai Porta Banner Roll Up
 - Banner con montaggio rapido
 - Cambio grafiche semplice e veloce
- ES**
 - Una alternativa inteligente para Roll-Banner
 - Banner con configuración rápida
 - Rápido y fácil cambio de impresiones
- FR**
 - Une alternative intelligente pour les Roll-Banners
 - Bannière avec configuration rapide
 - Changement rapide et facile des visuels



Art. nr.	Dimensions (cm)		
	W	H	KG
LBQ080	80	200	1,3

Single-piece cardboard packaging not standard included

L-BANNER TELESCOPIC

- IT**
 - Banner prestigioso con finitura elegante
 - Altezza regolabile
 - Attacco e cambio stampa facili
- ES**
 - Bandera de lujo con elegante acabado
 - Altura ajustable
 - Enlace dos sistemas con el conector opcional L-Banner
- FR**
 - Bannière de luxe avec finition élégante
 - Hauteur réglable
 - Interconnectez deux systèmes avec le connecteur L-Banner en option



Art. nr.	Dimensions (cm)		
	W	H	KG
LB080	80	160 - 220	2,4
LB085	85	160 - 220	2,5

Single-piece cardboard packaging not standard included

Available in 2 types of graphic materials (see p. 288 - 289)

See accessories page for options (p. 228)

X-BANNER BUDGET

- IT**
 - Facile e veloce da assemblare
 - Sistema a malapena visibile
 - L'alternativa più conveniente a un Porta Banner Roll Up
- ES**
 - Rápido y fácil de montar
 - Sistema apenas visible
 - Alternativa más rentable para un Roll-Banner
- FR**
 - Rapide et facile à assembler
 - Système à peine visible
 - Alternative la plus économique pour un Roll- Banner



Art. nr.	Dimensions (cm)		
	W	H	KG
XBB60-160	60	160	0,4
XBB80-180	80	180	0,4
XBB80-200	80	200	0,4



Single-piece cardboard packaging not standard included

X-BANNER PREMIUM

- IT**
 - Treppiede in alluminio con sommità in fibra
 - Cambio grafiche semplice e veloce
 - Sistema a malapena visibile
- ES**
 - Trípode de aluminio con tapas de fibra
 - Cambio rápido y fácil de impresiones
 - Sistema apenas visible
- FR**
 - Trépied en aluminium avec dessus en fibre
 - Changement rapide et facile des visuels
 - Système à peine visible



Art. nr.	Dimensions (cm)		
	W	H	KG
XBP060	60	160	1,3
XBP080	80	180	1,4
XBP100	100	200	1,6



Single-piece cardboard packaging not standard included

216 Available in 2 types of graphic materials (see p. 288 - 289)

See accessories page for options (p. 228)

INTERLOCKING BASE

- IT**
 - Soluzione pannello autoportante economico
 - I pannelli possono essere ancorati al supporto
 - Cartello ideale per negozi
- ES**
 - Solución económica para panel publicitario
 - Paneles con orificios en la parte inferior para fijación segura con tornillos
 - Publicidad ideal para tiendas
- FR**
 - Solution économique de panneau sur pied
 - Panneaux percés dans la partie inférieure pour fixer les boulons de sécurité
 - Panneau d'affichage idéal en magasin



Art. nr.	DIN/Size	Dimensions (cm)			
		W	H	D	KG
BH60	60	60	18	54	8,2
BH80	80	80	18	54	11,1



Perfect for use of dibond panels

PANEL BASE ALUMINIUM

- IT**
 - Base in alluminio stabile con piedini in silicone antiscivolo
 - Adatta a pannelli spessi da 3 a 26 mm
 - Ideale da utilizzare come cartello per negozi
- ES**
 - Base de aluminio estable con pies de silicona antideslizantes
 - Adecuado para paneles de 3 a 26 mm de espesor
 - Ideal para usar en tiendas
- FR**
 - Base stable en aluminium avec pieds en silicone antidérapant
 - Convient aux panneaux de 3 à 26 mm d'épaisseur
 - Idéal comme panneau d'affichage d'un magasin



Art. nr.	Ø	Dimensions (cm)			
		W	H	D	KG
PBAS30	30	14	38	7	
PBAS50	50	14	38	10	
PBAB30	30	14	38	7	
PBAB50	50	14	38	10	



Perfect for use of dibond panels

Graphic available

217

NEW



PANEL BASE STEEL

- IT**
- Espositore ideale per negozi
 - Elegante base in acciaio nero
 - Piedini in silicone antiscivolo
- ES**
- Señalización ideal para tiendas
 - Base elegante de acero de color negro
 - La base con pies de silicona antideslizante
- FR**
- Enseigne idéale pour les magasins
 - Élégant socle en acier noir
 - Pieds en silicone antidérapants



Art. nr.	Dimensions (cm)			
	W	H	D	KG
PBS400x400C9005	40	4	41,4	5



BESTSELLER



also with eco print material

ZIPPER-BANNER SLIM

- IT**
- Ottima alternativa al Porta Banner Roll Up standard
 - Rivestimento in tessuto senza pieghe su un lato o bifacciale
 - Sistema a scatto facile da montare
- ES**
- Una gran alternativa para el Roll Banner estándar
 - Individual o doble cara, con sistema antiarrugas
 - Fácil de montar con sistema de clic
- FR**
- Excellente alternative au roll-up standard
 - Revêtement en tissu infroissable sur une ou deux faces
 - Système clic-clac facile à assembler



Art. nr.	Dimensions (cm)		
	W	H	KG
ZBSLIM080-200	80	200	2,4
ZBSLIM085-200	85	200	2,6
ZBSLIM100-200	100	200	2,9

220 Graphic available

ZIPPER-WALL BANNER

- IT**
- Lussuoso banner bifacciale con rivestimento in tessuto anti piega
 - Con base nera in acciaio
 - Può essere completamente smontato per facilitare il trasporto
- ES**
- Banner de doble cara de lujo con tela lisa y sin arrugas
 - Con base de acero negro
 - Completamente desmontable para un fácil transporte
- FR**
- Bannière double face luxueuse avec revêtement en tissu sans plis
 - Avec base en acier noir
 - Peut être entièrement démontée pour faciliter le transport



Art. nr.	Dimensions (cm)			
	W	H	D	KG
ZWB080-200	80	200	25	8,3
ZWB100-200	100	200	25	9,9

- Optional: LED Lighting and Clamp Tube (see chapter 18. Walls (p. 277))
- Graphic available





FABRIC BANNER SLEEVE

- IT**
- Elegante design bifacciale che attira l'attenzione sulla promozione
 - Sistema leggero che si monta senza utensili
 - Soluzione banner conveniente

- ES**
- Innovador, diseño a de doble cara para llamar la atención hacia la promoción
 - Un sistema ligero sin necesidad de herramientas para su montaje
 - Una solución de banner asequible

- FR**
- Conception innovante, double-face, pour attirer l'attention sur la promotion
 - Système léger avec montage sans outil
 - Une solution de bannière économique



Art. nr.	DIN/Size	Dimensions (cm)			KG
		W	H	D	
ZWBS40x180	40 x 180	40	180,9	35	4,3
ZWBS60x200	60 x 200	60	201,1	35	6,1
ZWBS80x220	80 x 220	80	221,1	35	7,8





ZIPPER-BANNER TRIANGLE

- IT**
- Lascia un ricordo indelebile con un'altezza di quasi 2,6 m
 - Bandiera e banner tutto in uno
 - Espositore in tessuto bifacciale con una forma innovativa
- ES**
- Cause una impresión de gran impacto con altura de casi 2,6 m
 - Banner y bandera en uno
 - Display de tela de doble cara con una forma innovadora
- FR**
- Laissez une méga-impression avec une hauteur de près de 2,6 m
 - Drapeau et bannière en un seul produit
 - Présentoir en tissu double face à la forme innovante



Art. nr.	Dimensions (cm)			
	W	H	D	KG
ZWBT-L	108	255,3	50	6,7





ZIP-UP ROUND AND SQUARE

- IT**
- Porta banner sospeso per la massima esposizione
 - Telaio tubolare in alluminio leggero
 - Installazione passo-passo rapida e facile

- ES**
- Banner colgante para una máxima exposición
 - Estructura ligera de aluminio tubular
 - Instalación rápida y fácil paso a paso

- FR**
- Bannière suspendue pour une exposition maximale
 - Cadre tubulaire léger en aluminium
 - Installation étape par étape rapide et facile

Art. nr.	Dimensions (cm)				
	Ø	W	H	D	KG
Round					
ZURS	152		61		6,7
ZURL	305		76		11
Square					
ZUSM	244	107	244		12,4

• Single-sided and double-sided graphics available



BANNER PROFILE

- IT**
- Sospensione sicura di banner in formati grandi e pesanti
 - Profilo a presa in alluminio per materiale di peso 400 - 750 g/m²
 - Cambio banner rapido e semplice
- ES**
- Suspensión segura para pósters pesados y de gran formato
 - Perfil de sujeción de aluminio que soporta 400 - 750 g/m² del material
 - Cambio de póster rápido y fácil
- FR**
- Suspension sûre des bannières lourdes et de grand format
 - Profil de pincement en aluminium pour matériau de poids de 400 - 750 g/m²
 - Changement facile et rapide de bannières

Art. nr.	Dimensions (cm)				KG
	W	H	D		
BP100	100,5	2,5	1,5		0,8
BP120	120,5	2,5	1,5		0,9
BP180	180,5	2,5	1,5		1,4
BP300	300,5	2,5	1,5		2,3
BP50	50,5	2,5	1,5		0,4
BP60	60,5	2,5	1,5		0,5
BP70	70,5	2,5	1,5		0,5
BP80	80,5	2,5	1,5		0,6
BP85	85,5	2,5	1,5		0,6

• Optional: Frame Hanging Kit (see p. 228)



SUSPENDED FLAG BANNER

- IT**
- Soluzione porta banner semplice, accessibile ed efficace
 - Bandiera stampata facile da appendere
 - Ideale per parrucchieri, centri estetici, showroom di auto

- ES**
- Solución de banner simple, asequible y efectiva
 - Bandera impresa fácil de colgar
 - Ideal para usar en peluquerías, salones cosméticos, salas de exposición de automóviles

- FR**
- Solution de bannière simple, abordable et efficace
 - Drapeau imprimé facile à accrocher
 - Idéal à utiliser chez les coiffeurs, les salons de beauté, les salles d'exposition de voitures

Art. nr.	Dimensions (cm)			
	W	H	D	KG
FLAGBA580x1200	58	120	10	0,4
FLAGBA580x1600	58	160	10	0,5
FLAGBA580x2000	58	200	10	0,7

• Available in 3 types of graphic materials (see p. 288 - 289)



LENGTHENING POLE

Accessory for Roll-Banner Basic



- IT • Palo allungabile di 20 cm in altezza
- ES • Poste alargador de 20 cm de altura
- FR • Poteau de rallonge de 20 cm de hauteur

Art. nr. P20RBBAS ●

BANNER LED

Accessory for all Roll-Banners



- IT • LED luminosi
- ES • Adecuado en otros sistemas con el 'Banner Light Clip' opcional
- FR • Convient aux autres systèmes avec le 'Banner Clip Light' en option

Art. nr. BLED3B ●
BLED3S ●

LUXURIOUS LIGHT BAG

Accessory for Banner LED



- IT • Adatto ad alloggiare 3 luci
- ES • Adecuado para almacenar 3 luces
- FR • Adapté au stockage de 3 éclairages

Art. nr. L-BAG-M

FRAME HANGING KIT

Accessory for Banner Profile



- IT • Kit di montaggio o sospensione da soffitto
- ES • Juego de suspensión o suspensión del techo
- FR • Kit de suspension ou suspension au plafond

Art. nr. HSKR

ALU STRIP

Accessory for Roll-Banner Premium Clamp and Roll-Banner Deluxe



- IT • Striscia in alluminio per cambio grafica semplice e rapido
- ES • Tira de aluminio para un cambio de impresión rápido y fácil
- FR • Bande alu pour changer le visuel rapidement et facilement

Art. nr. SPRB0200 ●
SPRB0201 ●



16. FLAGS

Bandiere
Banderas
Drapeaux

Flags are a great way to get people's attention in both indoor and outdoor settings. Flags are a popular choice among petrol stations, car companies, restaurants, retail shops, shopping centres and sport events. Quick and easy to set up and visible from a distance. Available in a variety of shapes and sizes.

INDEX

16.1 Indoor Flags **232**
Bandiere da interno
Banderas para Interior
Drapeaux intérieur

16.2 Outdoor Flags **236**
Bandiere da esterno
Banderas para Exterior
Drapeaux d'extérieur

16.3 Accessories **242**
Accessori
Accesorios
Accessoires

- GRAPHIC AVAILABLE TO CUSTOMISE YOUR FLAG
- WIDE RANGE OF DESIGNS AND COMBINATIONS
- GREAT SOLUTION FOR EVERY SITUATION, INDOOR OR OUTDOOR



GOOD

BEACH FLAG BUDGET WIND

- Economic flag with great quality
- One system for two shapes
- Suitable for both wind and drop shaped flags



BETTER

BEACH FLAG FIBER WIND

- One system for three shapes
- Suitable for wind, drop and paddle shaped flags
- Flexible fiberglass flag pole



BEST

BEACH FLAG ALU WIND

- Most popular Beach Flag
- Fits everywhere, from gas stations to shopping centres and events
- Thick aluminium flag pole, Ø 28 mm



MICRO FLAG

- IT**
- Elegante bandiera da tavolo con base in alluminio
 - Bandiera classica a forma di goccia su un lato o bifacciale
 - Assemblaggio rapido e semplice
- ES**
- Tableros elegantes con base de aluminio
 - Bandera en forma pluma clásica a una o dos caras
 - Montaje fácil y rápido
- FR**
- Élégant présentoir de table avec base en aluminium
 - Drapeau en forme de goutte, simple et double face - Forme classique
 - Installation facile et rapide

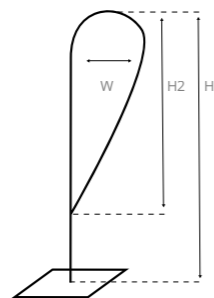

Art. nr.	Dimensions (cm)			
	Flag size: W	Pole height: H1	Flag size: H2	KG
BFMIC60	23	45	8	0,1

- Ideal for brand promotion at car dealers, shops or exhibition booths
- Single-sided and double-sided graphics available



WINDOW FLAG WIND & DROP

- IT**
- Configurazione rapida e semplice con angolazione regolabile
 - Elegante design nero con ventosa bloccabile sofisticata
 - Un sistema adatto a bandiere sia a vela sia a goccia
- ES**
- Montaje fácil y rápido con un ángulo ajustable
 - El diseño negro elegante con un sistema sofisticado de ventosa con cierre
 - El mismo sistema compatible con ambas variantes, tanto con la bandera en forma de vela como con la bandera en forma de gota
- FR**
- Installation facile et rapide avec un angle réglable
 - Conception noire élégante avec une ventouse sophistiquée
 - Un seul système convenant à la fois aux drapeaux flottants et en forme de goutte



Art. nr.	Dimensions (cm)			
	Flag size: W	Pole height: H1	Flag size: H2	KG
WINFLAG (wind shape)	24	92	67	0,1
WINFLAG (drop shape)	28	78	50	0,1



- For both indoor and outdoor use
- Single-sided and double-sided graphics available



• Graphic available

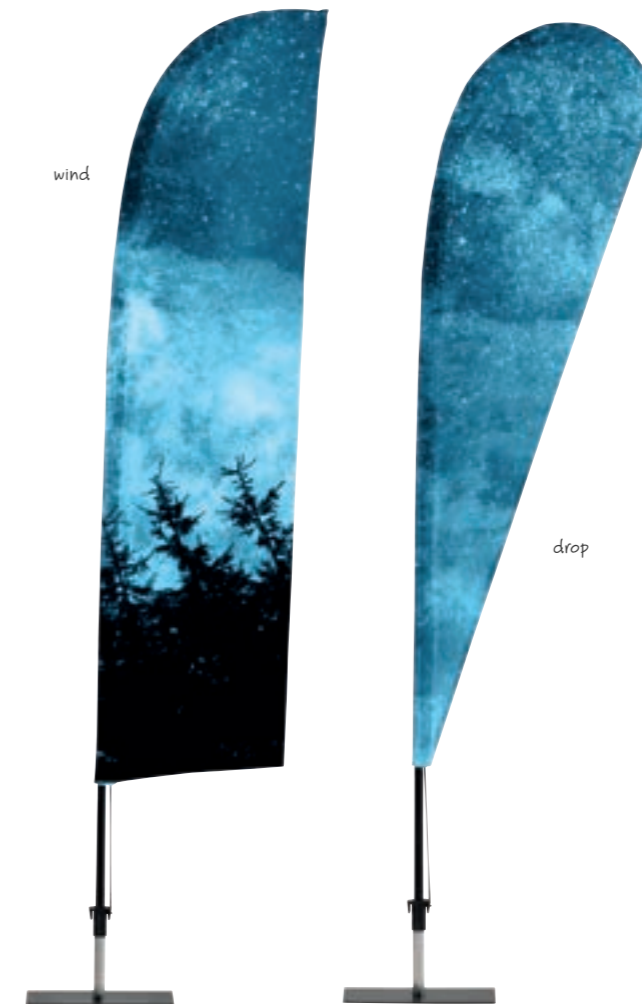

PROMO FLAG WIND & DROP

- IT**
- Bandiera indoor professionale
 - Sistema a scatto facile da montare
 - Piastra in acciaio nero opaco con supporto rotatore incluso
- ES**
- Bandera profesional de interior
 - Sistema de clic fácil de montar
 - Placa de acero negro mate con soporte giratorio incluido
- FR**
- Drapeau d'intérieur professionnel
 - Système clic-clac facile à assembler
 - Plaque en acier noir mat avec support de rotateur inclus

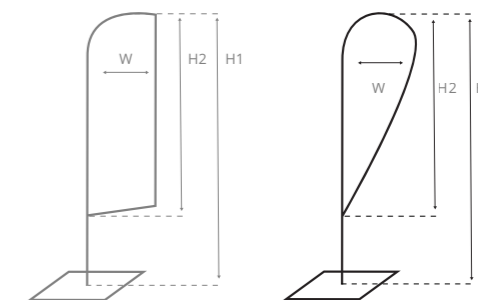

Art. nr.	Dimensions (cm)			
	Flag size: W	Pole height: H1	Flag size: H2	KG
PROFLAG (wind shape)	42	205	163	2,4
PROFLAG (drop shape)	49	196	150	2,4

🔩 Steel base included





single-sided version also with eco print material

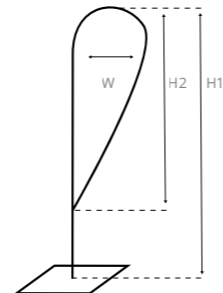
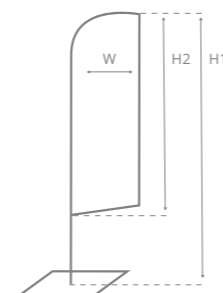

BEACH FLAG BUDGET WIND & DROP

- IT**
- Beach flag economica di grande qualità
 - Un sistema per due forme
 - Adatto a bandiere sia a vela sia a goccia
- ES**
- Bandera económica de gran calidad
 - Un sistema para dos formas
 - Apto para banderas con forma de viento y de gota
- FR**
- Drapeau économique de grande qualité
 - Un système pour deux formes
 - Convient aux drapeaux en forme classique et forme de goutte

Art. nr.	Dimensions (cm)			
	Flag size:		Pole height:	
	W	H1	H2	KG
Wind				
BFB-S	56,9	248	202,6	0,4
BFB-M	62	301,5	268	0,5
BFB-L	81,5	399	336,5	0,6
BFB-XL	87,6	499	460	1
Drop				
BFB-S	78	215,5	178	0,4
BFB-M	97,5	259,5	211	0,5
BFB-L	112	337	275	0,6
BFB-XL	122	435	366	1



- ❗ Base with 17 mm rotator is not included
- ➕ Optional: Luxurious Padded Transporter Bag (see p. 242)



BEACH FLAG BUDGET SQUARE

- IT**
- Beach flag economica di grande qualità
 - Grande area grafica visiva
 - Palo in alluminio
- ES**
- Bandera económica de gran calidad
 - Gran superficie para su diseño
 - Mástil de aluminio
- FR**
- Drapeau économique de grande qualité
 - Grande zone graphique visuelle
 - Poteau en aluminium

Art. nr.	Dimensions (cm)			
	Flag size:		Pole height:	
	W	H1	H2	KG
BFBS-S	62	180	97	0,6
BFBS-M	62	235	152	0,7
BFBS-L	75	343,5	256	1
BFBS-XL	86,5	440	351	1,3

- ❗ Base with 17 mm rotator is not included
- ➕ Beach Flag Bases see (p. 242 and 243)
- ➕ Optional: Luxurious Padded Transporter Bag (see p. 242)
- ➕ Graphic available

Beach Flag Alu Paddle (p. 238/ch. 16)



single-sided version also with eco print material



NEW



single-sided version also with eco print material



one system for two shapes

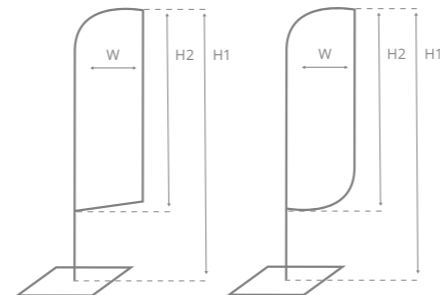

BEACH FLAG ALU WIND & PADDLE

- IT**
 - La bandiera più venduta
 - Adatta ovunque, dalle stazioni di servizio ai centri commerciali e agli eventi
 - Palo bandiera in alluminio spesso, Ø 28 mm
- ES**
 - La bandera más popular
 - Se adapta a todas partes, desde estaciones de servicio hasta centros comerciales y eventos
 - Mástil grueso de aluminio, Ø 28 mm
- FR**
 - Beach Flag le plus populaire
 - Convient partout, des stations-service aux centres commerciaux et aux événements
 - Poteau de pavillon en aluminium épais, Ø 28 mm



Art. nr.	Dimensions (cm)				KG
	Flag size: W	Pole height: H1	Flag size: H2	Flag size: H1	
BFAW205	86	192	162	0,8	
BFAW255	86	242	192	0,9	
BFAW310	86	295	233	1,1	
BFAW360	86	351	284	1,2	
BFAW415	86	400	337	1,5	
BFAW465	86	455	388	1,8	
BFAW520	86	511	439	2	

- ❶ Base with 25 mm rotator is not included
- ❷ Optional: Luxurious Padded Transporter Bag (see p. 242)



➤ Beach Flag Bases see (p. 242 and 243)

BEACH FLAG ALU DROP

- IT**
 - Aspetto lussuoso con palo bandiera verniciato a polvere nero
 - Sempre tesa grazie alla forma a goccia
 - Palo bandiera in alluminio spesso, Ø 28 mm
- ES**
 - Aspecto elegante con una bandera con mástil recubierto en color negro
 - Siempre tensado gracias a la forma de la gota
 - Mástil grueso de aluminio, Ø 28 mm
- FR**
 - Aspect luxueux avec mât de pavillon thermolaqué noir
 - Toujours serré grâce à la forme de goutte
 - Mât de pavillon en aluminium épais, Ø 28 mm

Art. nr.	Dimensions (cm)			
	Flag size: W	Pole height: H1	Flag size: H2	Flag size: H1
BFAD235	84	225	183	0,9
BFAD290	84	276	236	1,2
BFAD345	84	330	281	1,4
BFAD400	105	390	325	1,6
BFAD520	124	503	425	2

- ❶ Base with 25 mm rotator is not included
- ❷ Optional: Luxurious Padded Transporter Bag (see p. 242)

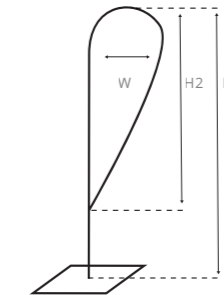

single-sided version also with eco print material



BEACH FLAG ALU SQUARE

- IT**
 - Grande area grafica visiva
 - Forma facile da progettare
 - Palo bandiera in alluminio spesso, Ø 28 mm
- ES**
 - Gran área gráfica visual
 - Forma fácil de diseñar
 - Mástil grueso de aluminio, Ø 28 mm
- FR**
 - Grande zone graphique visuelle
 - Forme facile à créer
 - Poteau indicateur en aluminium épais, Ø 28 mm

Art. nr.	Dimensions (cm)			
	Flag size: W	Pole height: H1	Flag size: H2	Flag size: H1
BFAS240	60	229	151	1,3
BFAS350	84	336	260	1,8
BFAS460	84	444	372	2,24

- ❶ Base with 25 mm rotator is not included
- ❷ Optional: Luxurious Padded Transporter Bag (see p. 242)

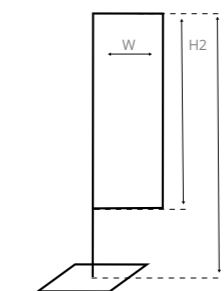

single-sided version also with eco print material



➤ Beach Flag Bases see (p. 242 and 243)

➤ Graphic available

NEW



single-sided version also with eco print material



BEACH FLAG FIBER DROP, WIND & PADDLE

- IT**
- Un sistema per tre forme
 - Adatto a bandiere sia a vela sia, a Paddle e a goccia
 - Materiale di stampa Eco disponibile

- ES**
- Un sistema con tres formas
 - Adecuado para banderas con forma Vela, Paddle y Gota
 - Mástil de fibra de vidrio flexible

- FR**
- Un système pour trois formes
 - Convient aux drapeaux flottants, Paddle et en forme de goutte
 - Hampe de drapeau en fibre de verre flexible

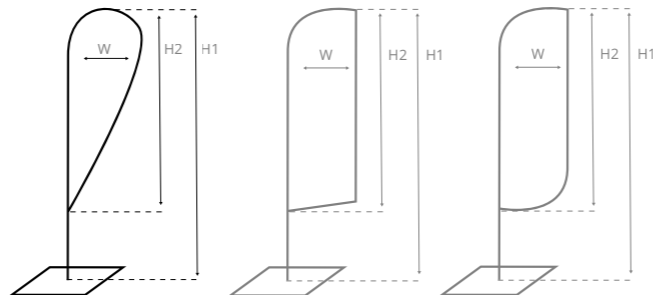

Art. nr.	Dimensions (cm)				KG
	Flag size:		Pole height:		
	W	H1	H2		
Drop					
BFF-S	56	171	136		0,5
BFF-M	65	218	175		0,7
BFF-L	109	282	231		0,9
BFF-XL	135	399	361		1,2
Wind & Paddle					
BFF-S	46	196	151		0,5
BFF-M	65	249	189		0,7
BFF-L	77	343	278		0,9
BFF-XL	78	471	394		1,2

- Base with 25 mm rotator is not included
- Optional: Luxurious Padded Transporter Bag (see p. 242)



FLAG POLE 540

- IT**
- Sistema bandiera estremamente grande
 - Base con quattro gambe in alluminio
 - Base stabile composta da due parti
- ES**
- Sistema de bandera extremadamente grande
 - Base de 4 patas de aluminio
 - Base estable de dos partes
- FR**
- Très grand système pour drapeau
 - Base en aluminium à 4 pattes
 - Base stable en deux parties

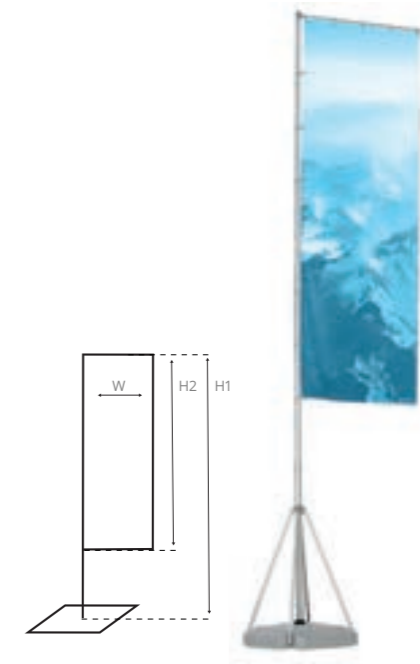

Art. nr.	Dimensions (cm)				
	Base	Flag size:		Pole height:	
	∅	W	H1	H2	Flag size: KG Tank: 10 Pole: 6,5
FP540	80 x 80	110	540	330	



*1 system fits in 2 boxes. 2 systems fit in 3 boxes.
Tanks always packed in a separate box. Poles per 2 in 1 box.

- Including extra weight for down force flag



LUXURIOUS PADDED TRANSPORTER BAG

Accessory for multiple Beach Flags



- IT** • Borsa da trasporto imbottita lussuosa per molteplici bandiere da spiaggia
- ES** • Bolsa de transporte acolchada de lujo para múltiples productos beachflag
- FR** • Sac de transport design et renforcé pouvant être utilisé pour différents beachflags

Art. nr. Suitable for BFF-M
AP-BF-BAG-LUXL

Suitable for all Beach Flags, except BFF-M
AP-BF-BAG-LUXXL

GROUND-DRILL

Accessory for all Beach Flags
17 mm for Budget Flags
25 mm for Alu and Fiber Flags



- IT** • Base perfetta per terreno solido
- ES** • Base perfecta para terreno sólido
- FR** • Base parfaite pour terrain compact

Art. nr. For Budget Flags
BF-GD-17

For Alu and Fiber Flags
BF-GD

GROUND-PIN

Accessory for all Beach Flags
17 mm for Budget Flags
25 mm for Alu and Fiber Flags



- IT** • Base adatta a un terreno compatto e semicompatto
- ES** • Base adaptée pour un sol compact et semi-compact
- FR** • Base adecuada para terrenos compactos y semi-compacto

Art. nr. For Budget Flags
BF-GP-17 Ground-Pin 60

For Alu and Fiber Flags
BF-GP60 Ground-Pin 60
BF-GP80 Ground-Pin 80

CAR-FOOT

Accessory for all Beach Flags
17 mm for Budget Flags
25 mm for Alu and Fiber Flags



- IT** • Adatto ad aree interne ed esterne
- ES** • Adecuado para uso en interiores y al aire libre
- FR** • Convient à une utilisation à l'intérieur et à l'extérieur

Art. nr. For Budget Flags
BF-CF-17

For Alu and Fiber Flags
BF-CF

LUXURIOUS STEEL PLATE

Accessory for all Beach Flags
17 mm for Budget Flags
25 mm for Alu and Fiber Flags



- IT** • Base elegante con rotatore cromato incluso
- ES** • Base elegante con rotador incluido
- FR** • Socle élégant avec rotateur chromé inclus

Art. nr. For Budget Flags
BF-ST6-17 Steel Plate 6 kg
BF-ST12-17 Steel Plate 12 kg

For Alu and Fiber Flags
BF-ST6 Steel Plate 6 kg
BF-ST12 Steel Plate 12 kg
BF-ST20 Steel Plate 20 kg
BF-ST12.20BAG Steel Plate 12 / 20 kg bag

WATER TANK

Accessory for all Beach Flags
17 mm for Budget Flags
25 mm for Alu and Fiber Flags



- IT** • Perfetta e adatta a tutte le superfici piane
- ES** • Perfecto para todas las superficies planas
- FR** • Parfait pour toutes les surfaces planes

Art. nr. For Budget Flags
BF-WT21-17 Water Tank 21 liter

For Alu and Fiber Flags
BF-WT21 Water Tank 21 liter
BF-WT24 Water Tank 24 liter

Bicycle Stand (p. 142/ch. 9), Natura Chalk Fast-Switch A-Board (p. 113/ch. 7), and Beach Flag Alu Drop (p. 239/ch. 16)



CROSS-BASE

Accessory for all Beach Flags
17 mm for Budget Flags
25 mm for Alu and Fiber Flags



- IT** • Una base leggera particolarmente adatta a un utilizzo interno
- ES** • Una base ligera que es más adecuada para uso en interiores
- FR** • Base légère qui convient principalement à une utilisation en intérieur

Art. nr. For Budget Flags
BF-CB30-17 Cross-Base 30

For Alu and Fiber Flags
BF-CB30 Cross-Base 30
BF-CB50 Cross-Base 50

WATER BAG

Accessory for Cross-Base



- IT** • Perfect to enhance the stability of the flags
- ES** • Perfecto para mejorar la estabilidad de las banderas
- FR** • Parfait pour améliorer la stabilité des drapeaux

Art. nr. BF-WB

SAND BAG

Accessory for Cross-Base



- IT** • Perfect to enhance the stability of the flags
- ES** • Perfecto para mejorar la estabilidad de las banderas
- FR** • Parfait pour améliorer la stabilité des drapeaux

Art. nr. BF-SB

17. COUNTERS AND TABLE COVERS

Banchette e tovaglie
Mostradores y Cubiertas de Mesa
Comptoirs et Housses de Table

Counters and Table Covers are very effective for communication and presentation during exhibitions and events. They are portable, easy to assemble without tools, provide full-colour graphics on the outside and storage space on the inside. You'll stay organised and look professional. Go for a well-dressed Table Cover to improve a company presentation at business conventions, hotel events, job fairs and much more. Setting up your promotional stand has never been so quick and easy.

INDEX

17.1 Counters and Accessories **246**
Banchetti e accessori
Mostradores y Accesorios
Comptoirs et Accessoires

17.2 Table Covers **258**
Tovaglie
Cubiertas de Mesa
Housses de Table

- **QUICK AND EASY TO ASSEMBLE**
- **DIFFERENT SHAPES AND SIZES AVAILABLE**
- **GRAPHIC AVAILABLE TO CUSTOMISE YOUR COUNTER OR TABLE COVER**



GOOD
COUNTER PROFESSIONAL ORIGINAL M

- Extremely stable because of curved shape
- Quick and easy to assemble
- Optional Plastic Shelf

BETTER
COUNTER IMPRESS

- Aluminium frame that holds Silicone Edge Graphics
- Equippable with LED-curtains for an eye-catching backlit effect
- One system suitable for with or without LED curtains

BEST
DIGITAL COUNTER FUTURO

- Premium counter with a digital presentation in landscape or portrait
- Easy to assemble
- Standard with black graphics on the sides (SEG)

GET THE FULL EXPERIENCE AND GO TO WWW.DIGITAL-COUNTER.COM

NEW



DIGITAL COUNTER FUTURO

- IT**
- Comptoir premium avec affichage digital en orientation paysage ou portrait
 - Assemblage facile
 - Modèle standard avec visuels noirs latéraux (SEG)
- ES**
- Mostrador premium con presentación digital en orientación horizontal
 - Fácil de montar
 - De serie con gráficos negros en los laterales (SEG)
- FR**
- Comptoir premium avec affichage numérique en orientation paysage
 - Assemblage facile
 - Modèle standard avec visuels noirs latéraux (SEG)



Art. nr.	Inch	Dimensions (cm)			
		W	H	D	KG
DICOUNTER32ESF	32"	72	92,8	44,5	23,1
DICOUNTER55ESF	55"	92,8	134,5	40,5	45,5

NEW





BRIGHTBOX COUNTER

- IT**
- Connettori elettrici interni al telaio per una facile installazione senza cavi
 - Telaio stabile da 100 cm
 - Lati magnetici collegabili per unire molteplici Banchetti Brightbox
- ES**
- Conectores eléctricos en el interior del marco para fácil instalación sin cableado
 - Marco estable de 100 cm
 - Laterales con imán enlazables para poder colocar varios Brightbox con mostrador juntos
- FR**
- Connecteurs électriques intégrés dans le cadre pour une installation facile sans câbles
 - Cadre stable de 100 cm
 - Côtés magnétiques pouvant être interconnectés pour relier plusieurs comptoirs Brightbox entre eux

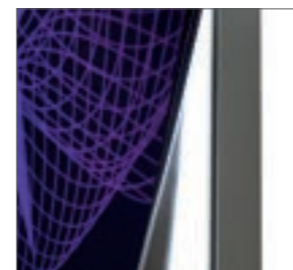

Art. nr.	Dimensions (cm)
	W H D KG
CBBOX-TTB	100 103 40 11

- Including Padded Carry Bag
- 6500 K colour temperature and Edge lit 24V LED Lights
- Optional: Block-Out for Backside (see p. 257)
- Perfect to combine with Brightbox Single, Double and XL
See chapter 3. Illuminated Displays (p. 57, 58 and 60)





COUNTER IMPRESS

- IT**
- Telaio in alluminio che sostiene Grafiche di Bordi in Silicone
 - Attrezzabile con tende a LED per un effetto retroilluminato accattivante
 - Un sistema adatto con o senza tende a LED
- ES**
- Estructura de aluminio que mantiene los gráficos con bordes de silicona
 - Equipable con cortinas LED para un llamativo efecto retroiluminado
 - Un sistema adecuado con o sin cortinas LED
- FR**
- Cadre en aluminium maintenant des Silicone Edge Graphics
 - Peut être équipé de rideaux LED pour un effet rétroéclairé accrocheur
 - Système adapté avec ou sans rideaux à LED



Art. nr.	Dimensions (cm)			
	W	H	D	KG
CIMTTB	106	104	40	17
CIMTTB-LED	106	104	40	20

- Graphic available
- Optional: Block-Out Set (3 pcs) for LED option (see p. 257)
- Optional: Black Graphic Backside with zipper to close the back of the counter (see p. 257)
- Perfect to combine with Pop-Up Impress and other fabric walls. See chapter 18. Walls (p. 260)



COUNTER FABRIC

- IT**
- Velcro resistente per attaccare le grafiche in modo facile e sicuro
 - Telaio pieghevole in alluminio, facile da riporre quando non viene utilizzato
 - Facile fissaggio e sostituzione della grafica in tessuto mediante velcro
- ES**
- Velcro resistente para una instalación de impresión fácil y segura
 - Estructura de aluminio plegable, fácil de guardar cuando no está en uso
 - Fácil cambio de impresión
- FR**
- Velcro robuste pour une fixation facile et sûre de l'impression
 - Cadre en aluminium pliable, facile à ranger lorsqu'il n'est pas utilisé
 - Visuel en tissu facilement interchangeable



Art. nr.	☒	Dimensions (cm)			
		W	H	D	KG
CFTTB	●	106	102	40	18
CFTTW	●	106	102	40	18
CFTTS	○	106	102	40	18
CFTTWH	○	106	102	40	18

- Graphic available
- Perfect to combine with Pop-Up Fabric (Premium) and other fabric walls. See chapter 18. Walls (p. 260)



COUNTER MAGNETIC

NEW: GRAPHIC AVAILABLE

- IT**
- Telaio in alluminio stabile e robusto
 - Ripiano in legno incluso
 - Perfetto combinato con il Pop-Up Magnetico
- ES**
- Estructura de aluminio estable y robusto
 - Estante de madera incluido
 - Perfecto en combinación con el Pop-Up Magnetic
- FR**
- Cadre en aluminium stable et robuste
 - Etagère en bois incluse
 - Parfait lorsqu'il est combiné avec le Pop-Up Magnetic



Art. nr.	☒	Dimensions (cm)			
		W	H	D	KG
CMTTB	●	126	97	44	17
CMTTLO	●	126	97	44	17

- Optional: Extra Kit for New Visuals (see p. 256)
- Perfect to combine with Pop-Up Magnetic. See chapter 18. Walls (p. 268)



COUNTER PROFESSIONAL ORIGINAL M

BESTSELLER

NEW: GRAPHIC AVAILABLE

- IT**
- Estremamente stabile grazie alla forma curva
 - Facile e veloce da assemblare
 - Ripiano in plastica opzionale
- ES**
- Extremadamente estable debido a su forma curva
 - Rápido y fácil de montar
 - Estante de plástico opcional
- FR**
- Extrêmement stable grâce à sa forme incurvée
 - Facile et rapide à assembler
 - Tablette en plastique en option



Art. nr.		Dimensions (cm)			
		W	H	D	KG
CPOMTTB	●	91	93	48	30
CPOMTTW	●	91	93	48	30
CPOMTTS	○	91	93	48	30
CPOMTTWH	○	91	93	48	30

- ⊕ **Optional: Plastic Shelf Round** (see p. 256)
- ⊕ **Perfect to combine with Pop-Up Magnetic.** See chapter 18. Walls (p. 268)

COUNTER EASY OVAL

NEW

- IT**
- Un design snello in una forma ovale
 - Borsa inclusa per un facile trasporto
 - Promozione senza grinze grazie al tessuto elastico con sistema SEG (Silicone Edge Graphic)
- ES**
- Diseño fino de forma ovalada
 - Incluye bolsa de transporte para fácil traslado
 - Promoción en tela sin arrugas gracias al borde de silicona (SEG)
- FR**
- Design mince de forme ovale
 - Sac de transport inclus pour faciliter le transport
 - Promotion infroissable grâce au tissu extensible Silicone Edge Graphic (SEG)



Art. nr.	Dimensions (cm)			
	W	H	D	KG
CEOTTB	59,5	101	39,5	6

- ⊕ **Graphic available**
- ⊕ **Perfect to combine with Zipper-Walls.** See chapter 18. Walls (p. 270)

COUNTER PROFESSIONAL ORIGINAL L

NEW: GRAPHIC AVAILABLE

- IT**
- Estremamente stabile grazie alla forma curva
 - Molto spazio per la presentazione e lo stoccaggio
 - Ripiano in legno opzionale
- ES**
- Extremadamente estable debido a su forma curva
 - Mucho espacio para presentación y almacenamiento
 - Estante de madera opcional
- FR**
- Extrêmement stable en raison de sa forme incurvée
 - Beaucoup d'espace pour la présentation et le stockage
 - Tablette en bois en option



Art. nr.		Dimensions (cm)			
		W	H	D	KG
CPOLTTB	●	120	93	48	15*

* In 2 boxes of 12 and 3 KG

- ⊕ **Optional: Wooden Shelf** (see p. 256)
- ⊕ **Perfect to combine with Pop-Up Magnetic.** See chapter 18. Walls (p. 268)



COUNTER PROFESSIONAL SQUARE

NEW: GRAPHIC AVAILABLE

- IT**
 - Estremamente stabile
 - Spazio pratico per la presentazione e lo stoccaggio
 - Ripiano in plastica opzionale
- ES**
 - Muy estable
 - Práctico espacio de presentación y almacenamiento
 - Estante de plástico opcional
- FR**
 - Extrêmement stable
 - Espace pratique pour la présentation et le rangement
 - Tablette en plastique en option



Art. nr.	Dimensions (cm)
	W H D KG
CPSTTB	100 93 40 31,5

Optional: Plastic Shelf Square (see p. 256)

COUNTER PROFESSIONAL ROUND

- IT**
 - Alla moda, elegante e dalla forma giocosa
 - Assemblaggio rapido e semplice
 - Grafica a 360°
- ES**
 - Elegante, con estilo y una forma original
 - Fácil y rápido de montar
 - Impresión de 360°
- FR**
 - Forme élégante, élégante et ludique
 - Assemblage facile et rapide
 - Impression à 360°



Art. nr.	Dimensions (cm)
	W H KG
CPRTTB	45 93 16

COUNTER PROMOTIONAL

- IT**
 - Completamente adesivo e un espositore a 2 m di altezza
 - Leggero e stabile
 - Ideale per campagne promozionali o dimostrazioni di prodotti
- ES**
 - Totalmente pegable y con 2 metros de altura
 - Ligero y estable
 - Ideal para usar en campañas promocionales o demostraciones de productos
- FR**
 - Entièrement autocollant avec un display à 2 m de hauteur
 - Léger et stable
 - Idéal pour les campagnes promotionnelles ou les démonstrations de produits

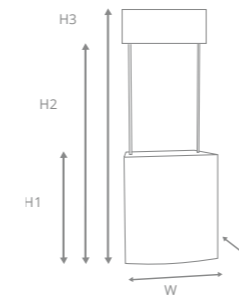

Art. nr.	Dimensions (cm)
	W H1 H2 H3 D KG
CPPROM	82 90 185 215 47 11

FLEX COUNTER

- IT**
 - Telaio in alluminio completamente ripiegabile
 - Alla moda, elegante e dalla forma giocosa
 - Facile e veloce da assemblare
- ES**
 - Estructura de aluminio completamente plegable
 - Elegante, con estilo y una forma divertida
 - Rápido y fácil de montar
- FR**
 - Cadre en aluminium entièrement pliable
 - Forme élégante, élégante et ludique
 - Assemblage rapide et facile



Art. nr.	Dimensions (cm)
	Ø H KG
FLC	58 106 17

Optional: 8 extra PVC panels for New Visuals (see p. 256)
 Perfect to combine with Flex Tower. See chapter 3. Illuminated Displays (p. 56)

PVC PANELS FOR NEW VISUALS

Accessory for Flex Counter



- IT** • 8 pannelli in PVC extra per nuove immagini
- ES** • 8 paneles de PVC adicionales para nuevas impresiones
- FR** • 8 panneaux PVC supplémentaires pour nouveaux visuels

Art. nr. FLP-SET

EXTRA KIT FOR NEW VISUALS

Accessory for Counter Magnetic



- IT** • Nastro magnetico extra per nuove immagini Banchetto Magnetico
- ES** • Cinta magnética adicional para nuevos visuales Counter Magnetic
- FR** • Bande magnétique supplémentaire pour les nouveaux visuels Counter Magnetic

Art. nr. CMKIT

PLASTIC SHELF ROUND

Accessory for Counter Professional Original M



- IT** • Ripiano in Plastica per Banchetto Professionale M
- ES** • Estante de plástico para Counter Professional M
- FR** • Étagère en plastique pour comptoir professionnel M

Art. nr. CPOMSHELF

BLOCK-OUT BRIGHTBOX

Accessory for Brightbox Counter



- IT** • Pellicola Block-Out senza interruzioni per impedire alla luce di uscire
- ES** • Película opaca sin costuras para evitar que salga la luz
- FR** • Film de blocage sans couture, pour empêcher la lumière de sortir

Art. nr. CBBOX-BO

BLOCK-OUT SET (3 PCS)

Accessory for Counter Impress



- IT** • Pellicola Block-Out senza interruzioni per impedire alla luce di uscire
- ES** • Película opaca sin costuras para evitar que salga la luz
- FR** • Film de blocage sans couture, pour empêcher la lumière de sortir

Art. nr. CIM-BO

➔ For sides and bottom

BLACK GRAPHIC BACKSIDE

Accessory for Counter Impress



- IT** • Retro con stampa nera e chiusura a cerniera
- ES** • Película opaca sin costuras para evitar que salga la luz
- FR** • Film de blocage sans couture, pour empêcher la lumière de sortir

Art. nr. CIM-BPZ

Pop-Up Impress Straight (p. 264/ch. 18), Pop-Up Impress Curved (p. 265/ch. 18) and Counter Impress (p. 250/ch. 17)

WOODEN SHELF

Accessory for Counter Professional Original L



- IT** • Ripiano in legno per Banchetto Professionale L
- ES** • Estantería de madera para Counter Professional L
- FR** • Étagère en bois pour comptoir professionnel L

Art. nr. CPOLSHELF

PLASTIC SHELF SQUARE

Accessory for Counter Professional Square



- IT** • Ripiano in Plastica per Banchetto Professionale Square
- ES** • Estante de plástico para Counter Professional Square
- FR** • Étagère en plastique pour comptoir professionnel carré

Art. nr. CPSSHELF

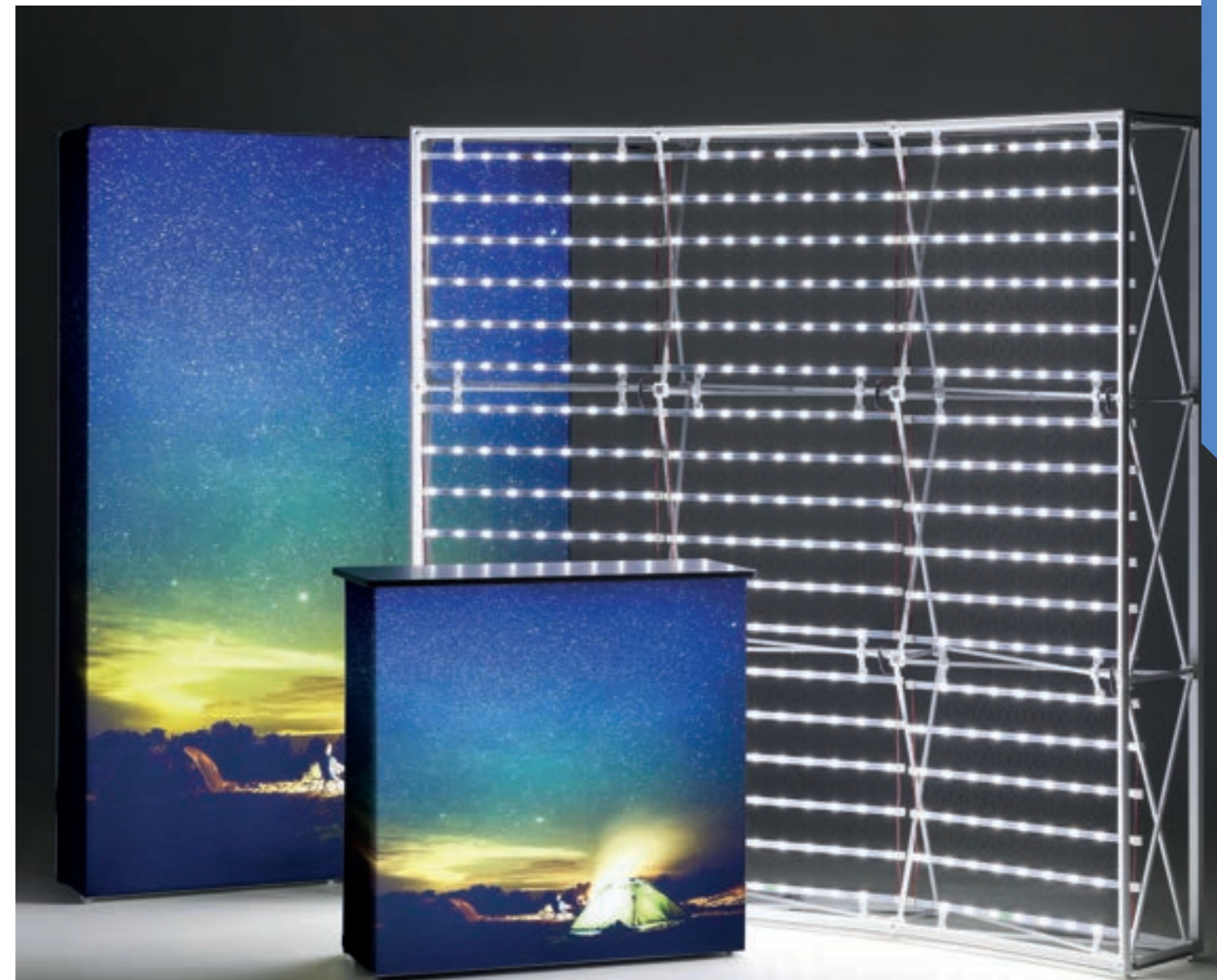



BEER TABLE COVER SET

- IT**
- Set di tovaglie in tessuto e due rivestimenti per panche per tavoli birreria standard
 - Popeline 100% PES
 - Classificazione antincendio B1
- ES**
- Juego de fundas de tela para la mesa de cerveza estándar que incluye una funda para la mesa y dos fundas para los bancos
 - Poli popelín 100% PES
 - Certificado ignífugo B1
- FR**
- Set de revêtement de table en tissu et de deux housses de banc pour tables de brasserie standards
 - Popeline Poly 100 % PES
 - Protection de classe B1 contre le feu

Art. nr.	Table size (cm)	Bench size (cm)	Dimensions (cm)			KG
			W	H	D	
Complete Set						
BSTBC180	50 x 180	25 x 180				
BSTBC200	50 x 200	25 x 200				
Table Cover						
BSTC180	50 x 180		182	12	52	0,3
BSTC200	50 x 200		202	12	52	0,3
Bench covers						
BSBC180		25 x 180	182	12	27	0,2
BSBC200		25 x 200	202	12	27	0,2

🔑 Table and bench are not included



TABLE COVER ECONOMY AND ROYAL ECONOMY

- IT**
- Design con apertura posteriore che offre spazio per le gambe
 - Spazio di stoccaggio nascosto facilmente accessibile
 - Lavabile in lavatrice e anti-piega
- ES**
- Diseño open-back que proporciona espacio para las piernas
 - Fácil espacio de almacenamiento fuera de la vista y accesible
 - Lavable a máquina y resistente a las arrugas
- FR**
- Conception avec partie arrière ouverte, offrant un espace pour les jambes
 - Espace de rangement facile d'accès
 - Lavable à la machine et résistant aux plis



Art. nr.	Table size (inch)	Table size (cm)	Dimensions (cm)		
			W	H	KG
Table Cover Economy					
TCES265-155GSUB	57,1" x 26,8" x 28"	145 x 68 x 74	265	155	0,7
TCES325-170GSUB	69,7" x 29,92" x 28"	177 x 76 x 74	325	170	0,8
TCES387-170GSUB	94,5" x 29,9" x 28"	387 x 76 x 74	387	170	0,9
Table Cover Royal Economy					
TCES72-30-28GSUB	72" x 30" x 28"	183 x 76 x 74	325	170	0,9
TCES96-30-28GSUB	96" x 30" x 28"	244 x 76 x 74	386	170	1,1

🔑 Suitable for logo printing and full-colour printing

Natura Chalk Board Classic (p. 115/ch. 7) and Table Cover Royal Economy (p. 259/ch. 17)



18. WALLS

Pareti Paneles Promocionales Murs

Leave an everlasting impression with one of the various walls. Pop-Ups and Zipper-Walls are durable, portable and decorative display systems for branding, promotions and a more impactful presentation. Set up and tear down in just a few minutes. Convenient transport cases keep you well organised and ready for the next event. The ideal solution for promotions, product presentations, trade shows and events.

- **QUICK AND EASY TO ASSEMBLE**
- **GRAPHIC AVAILABLE TO CUSTOMISE YOUR WALL**
- **VARIOUS LIGHT OPTIONS TO PUT YOURSELF IN THE SPOTLIGHT**



INDEX

18.1 Lightboxes <i>Cassonetti luminosi</i> <i>Cajas de luz</i> <i>Caissons lumineux</i>	262
18.2 Pop-Ups <i>Pop-ups</i> <i>Pop-Ups</i> <i>Stands Parapluie</i>	264
18.3 Zipper-Walls <i>Zipper-Walls</i> <i>Estructuras Tubulares</i> <i>Zipper-Wall</i> <i>Structures Tubulaires</i> <i>Zipper-Wall</i>	268
18.4 Other Walls <i>Altre pareti</i> <i>Otras Paneles</i> <i>Autres Murs</i>	272



GOOD POP-UP FABRIC

- Easy attachment and replacement of fabric graphic with Velcro
- Tool-free installation in less than 5 minutes
- Choose a stable mobile trolley case or a soft bag

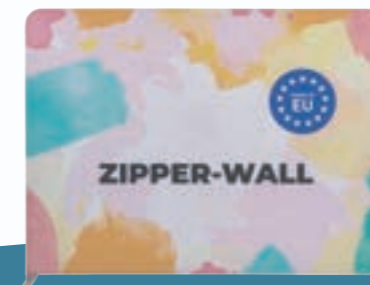

BETTER ZIPPER-WALL STRAIGHT BASIC

- Classic 32 mm frame for a great impression
- Easy and quick to assemble thanks to tool-free assembly
- Produced in our production centre in the Czech Republic



BEST POP-UP IMPRESS CURVED

- White curved aluminium frame that holds Silicone Edge Graphics
- Smooth curved back wall
- Equipable with LED-curtains for an eye-catching backlit effect



BRIGHTBOX XL

- IT**
- Perfetto per esposizioni promozionali a breve termine
 - Montaggio e sostituzione grafiche in tessuto semplici (SEG)
 - Alternativa economica a Pop-Up Impress

- ES**
- Perfecto para promociones cortas durante las ferias
 - Fácil colocación y cambio de gráfica de tela (SEG)
 - Una alternativa asequible para Pop-Up Impress

- FR**
- Parfait pour les promotions à court terme lors des expositions
 - Fixation et remplacement faciles des visuels en tissu (SEG)
 - Une alternative économique pour Pop-Up Impress



Art. nr.	DIN/Size	Dimensions (cm)			
		W	H	D	KG
BBOXXL300-240	300 x 240	242	300,3	41,9	21,4

- ⊕ Great addition to the Brightbox Family
- ⊕ Perfect to combine with Brightbox Counter. See ch. 17 Counters and Table Covers (p. 248)



BRIGHTBOX SINGLE

See 3. Illuminated Displays page 57



BRIGHTBOX DOUBLE

See 3. Illuminated Displays page 58



BRIGHTBOX COUNTER

See 17. Counters and Table Covers page 248



BESTSELLER



POP-UP IMPRESS STRAIGHT

- IT**
- Il sistema Pop-Up per grafiche SEG con bordo in silicone più resistente sul mercato
 - Barre facilmente agganciabili con doppie scanalature profonde 14 mm
 - Tutti i sistemi sono adatti all'utilizzo con o senza tendine a LED
- ES**
- El sistema Pop-Up más resistente del mercado
 - Barras fáciles de colocar con ranuras dobles de 14 mm de profundidad
 - Todos los sistemas son adecuados para usar con o sin cortinas LED
- FR**
- Le système SEG Pop-Up le plus solide et le plus évolué du marché
 - Barres faciles à fixer avec rainures doubles de 14 mm de profondeur
 - Tous les systèmes sont adaptés pour une utilisation avec ou sans rideaux LED

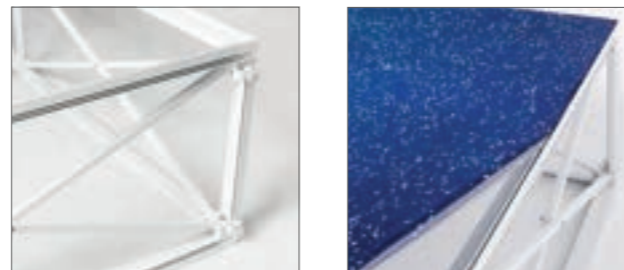

Art. nr.		DIN/Size	Dimensions (cm)				KG	
Without LED	With LED & Bars		W	H	D	KG	KG	
IMPR23S	IMPR23S-LEDPACK	2 x 3	151	224	36	13,6	28,4	
IMPR33S	IMPR33S-LEDPACK	3 x 3	224	224	36	16	34,6	
IMPR43S	IMPR43S-LEDPACK	4 x 3	298	224	36	18	41,6	
IMPR53S	IMPR53S-LEDPACK	5 x 3	371	224	36	21,3	50,3	
IMPR63S	IMPR63S-LEDPACK	6 x 3	444	224	36	23,2	56,2	
IMPR34S	IMPR34S-LEDPACK	3 x 4	224	298	36	19	37,5	
IMPR44S	IMPR44S-LEDPACK	4 x 4	298	298	36	21,3	43,7	
IMPR54S	IMPR54S-LEDPACK	5 x 4	371	298	36	24,8	52,5	

- Graphic available in standard and backlit graphic material
- Optional: Connectors, LED Light Curtains, LED Lighting, Extra Bars for Backside, Block-Out Film Backside and Feet (see p. 265 and 266)
- Perfect to combine with Counter Impress. See chapter 17. Counters and Table Covers (p. 250)



POP-UP IMPRESS CURVED

- IT**
- Telaio in alluminio curvo che sostiene Grafiche di Bordi in Silicone
 - Fondo liscio e curvo
 - Attrezzabile con tende a LED per un effetto retroilluminato accattivante
- ES**
- Marco de aluminio curvo blanco que mantiene los gráficos con borde de silicona
 - Pared trasera lisa y curvada
 - Equipable con cortinas LED para un llamativo efecto retroiluminado
- FR**
- Cadre en aluminium blanc incurvé qui supporte des Silicone Edge Graphics
 - Paroi arrière lisse courbée
 - Peut être équipé avec des rideaux LED pour un effet rétroéclairé accrocheur



Art. nr.		DIN/Size	Dimensions (cm)				KG	
Without LED	With LED & Bars		W	H	D	KG	KG	
IMPR33C	IMPR33C-LEDPACK	4 x 3	233	224	57	16	34,6	

- Graphic available in standard and backlit graphic material
- Optional: Connectors, LED Light Curtains, LED Lighting, Extra Bars for Backside, Block-Out Film Backside and Feet (see p. 265 and 266)
- Perfect to combine with Counter Impress. See chapter 17. Counters and Table Covers (p. 250)



CONNECTOR STRAIGHT SET

Accessory for Pop-Up Impress Straight and Pop-Up Impress Curved



- IT**
- Unione di due pareti in linea retta
- ES**
- Une dos Pop Ups entre sí en línea
- FR**
- Relie deux murs en ligne droite

Art. nr. IMPR-SC

CONNECTOR 90 DEGREES SET

Accessory for Pop-Up Impress Straight



- IT**
- Unione di due pareti con un'angolazione a 90 gradi
- ES**
- Une dos pop-ups en un ángulo de 90 grados
- FR**
- Relie deux murs formant un angle de 90 degrés

Art. nr. IMPR-CC

LED LIGHT SET FOR BACKLIT DISPLAY

Accessory for Pop-Up Impress Straight, Pop-Up Impress Curved



- IT** • Tende a LED retroilluminate separate compresa la Pellicola Black-Out per la parte inferiore, superiore e le due laterali
- ES** • Cortinas de luz LED retroiluminadas con un film de bloqueo en la parte posterior, superior y laterales
- FR** • Rideaux rétro éclairés pour LED séparés, avec film Blockout pour le bas, le haut et les côtés

Art. nr.	IMPR23S-LEDSET	IMPR54S-LEDSET
	IMPR33S-LEDSET	IMPR63S-LEDSET
	IMPR34S-LEDSET	IMPR73S-LEDSET
	IMPR43S-LEDSET	IMPR83S-LEDSET
	IMPR44S-LEDSET	IMPR84S-LEDSET
	IMPR53S-LEDSET	
	IMPR33C-LEDSET	

EXTRA BARS FOR BACKSIDE

Accessory for Pop-Up Impress Straight, Pop-Up Impress Curved



- IT** • Barre extra per aggiungere grafiche senza interruzioni o Pellicola Black-Out sul telaio posteriore di PopUp Impress
- ES** • Barras adicionales para agregar diseños a la parte posterior del Pop-Up Impress
- FR** • Barres supplémentaires pour ajouter un graphique transparent ou un film block-out à l'arrière du cadre Pop-Up Impress

Art. nr.	IMPR23S-BARB	IMPR54S-BARB
	IMPR33S-BARB	IMPR63S-BARB
	IMPR34S-BARB	IMPR73S-BARB
	IMPR43S-BARB	IMPR83S-BARB
	IMPR44S-BARB	IMPR84S-BARB
	IMPR53S-BARB	
	IMPR33C-BARB	

BLOCK-OUT FILM BACKSIDE

Accessory for Pop-Up Impress Straight, Pop-Up Impress Curved



- IT** • Pellicola Black-Out senza interruzioni per il telaio posteriore di Pop-Up Impress
- ES** • Película de bloqueo perfecta para el marco de Pop-Up Impress de la parte trasera
- FR** • Film de blocage transparent pour l'arrière du cadre Pop-Up Impress

Art. nr.	IMPR23S-BOB	IMPR54S-BOB
	IMPR33S-BOB	IMPR63S-BOB
	IMPR34S-BOB	IMPR73S-BOB
	IMPR43S-BOB	IMPR83S-BOB
	IMPR44S-BOB	IMPR84S-BOB
	IMPR53S-BOB	
	IMPR33C-BOB	

POP-UP FABRIC

- IT** • Fissaggio e sostituzione facile della stampa su tessuto mediante velcro
- Installazione senza utensili in meno di 5 minuti
- Scegliete il trolley rigido o la borsa per il trasporto
- ES** • Fácil fijación y cambio de tela con velcro
- Instalación sin herramientas en menos de 5 minutos
- Elija entre maleta rígida o bolsa blanda
- FR** • Fixation et remplacement faciles de l'imprimé en tissu avec du Velcro
- Installation sans outil en moins de 5 minutes
- Choisissez un trolley ou un sac souple



Art. nr.	DIN/Size	Dimensions (cm)				KG
		W	H	D		
Trolley Case						
PUF23S	2 x 3	151	224	30		13,5
PUF33S	3 x 3	224	224	30		15,5
PUF43S	4 x 3	297	224	30		17,5
PUF53S	5 x 3	370	224	30		19,5
Soft Bag						
PUF33S-SB	3 x 3	224	224	30		9
PUF43S-SB	4 x 3	297	224	30		11



Perfect to combine with Counter Fabric. See chapter 17. Counters and Table Covers (p. 251)



FEET

Accessory for Pop-Up Impress Straight, Pop-Up Impress Curved



- IT** • Piedini facilmente applicabili per una maggiore stabilità e un tocco elegante nella finitura
- ES** • Pies fáciles de conectar para mayor estabilidad y un toque final elegante
- FR** • Pieds faciles à fixer pour plus de stabilité et une finition élégante

Art. nr.	IMPR-FTWH	○
	IMPR-FTS	●
	IMPR-FTB	●

Recommended for more stability. Especially for frames of more than 6 levels wide

POP-UP FABRIC PREMIUM STRAIGHT

- IT** • Profili in alluminio estremamente robusti e prestigiosi
- Fissaggio e sostituzione facile della stampa su tessuto mediante velcro
- Installazione senza utensili in meno di 5 minuti
- ES** • Perfiles de aluminio extremadamente resistentes y lujosos
- Fácil colocación y sustitución de la tela gracias al velcro
- Instalación sin herramientas en menos de 5 minutos
- FR** • Profils en aluminium extrêmement robustes et luxueux
- Fixation et remplacement faciles de l'imprimé en tissu avec du velcro
- Installation sans outil en moins de 5 minutes



Art. nr.	DIN/Size	Dimensions (cm)				
		W1	W2	H	D	KG
PUFP33S	3 x 3	220	256	220	36	16
PUFP43S	4 x 3	292	328	220	36	18
PUFP53S	5 x 3	363	399	220	36	21



Optional: LED Lighting (see p. 271)
 The Pop-Up Fabric Premium Straight is fully equipped with Velcro for double-sided use
 Perfect to combine with Counter Fabric. See chapter 17. Counters and Table Covers (p. 251)



POP-UP MAGNETIC

- IT**
- Sistema a scatto pratico con magneti rinforzati da 12 mm
 - Custodia rigida convertibile in banchetto
 - Disponibile in versione curva e dritta
- ES**
- Sistema de clic práctico con imanes de potencia reforzados de 12 mm
 - Maleta convertible en mostrador
 - Disponible en versión curva y recta
- FR**
- Système de clic pratique avec de puissants aimants renforcés de 12 mm
 - Valise rigide convertible en comptoir
 - Disponible en version incurvée et droite

Art. Nr. Hardcase	Art. Nr. Soft Trolley	Dimensions (cm)			KG Hard Case	KG Soft Trolley
		W	H	D		
Straight						
PUM23S	-	197	224	32	27	-
PUM33S	PUM33S-ST	270	224	32	29	23
PUM43S	PUM43S-ST	343	224	32	31	27
PUM53S	PUM53S-ST	417	224	32	33	31
Curved						
PUM23C	-	192	224	51	27	-
PUM33C	PUM33C-ST	252	224	69	29	23
PUM43C	PUM43C-ST	301	224	100	31	27
PUM53C	PUM53C-ST	341	224	129	33	31



- Perfect to combine with Counter Magnetic. See chapter 17. Counters and Table Covers (p. 251)
- Optional: Table Top for Hardcase, Extra Kit for New Visuals, Bag for New or Backside Visuals, Extension Kit for Backside and LED lighting (see p. 269 and 277)

POP-UP TOWER

- IT**
- Telaio in alluminio con cerniere e chiusura magnetica
 - Pannelli grafiche senza interruzioni a 360°
 - Compatta e facile da stoccare
- ES**
- Estructura de aluminio con bisagras y cierre magnético
 - Paneles gráficos sin costura de 360°
 - Compacto y fácil de almacenar
- FR**
- Cadre en aluminium avec charnières et verrouillage magnétique
 - Panneaux graphiques sans couture à 360°
 - Compact et facile à ranger



Art. nr.	Dimensions (cm)		
	Ø	W	KG
PWTWR	64	225	16,5

- Included: Kit for new visuals, including plastic top strips (hangers) and magnetic tape (3-poles) with strong TESA self-adhesive
- Optional: Wall LED 50 (see p. 269)

EXTRA KIT FOR NEW VISUALS

Accessory for Pop-Up Magnetic



- IT**
- Nastro magnetico (3 pali) con autoadesivo resistente TESA
- ES**
- Cinta magnética (3 polos) con fuerte autoadhesivo TESA
- FR**
- Ruban magnétique (3 poteaux) avec adhésif TESA résistant

Art. nr.	PUM33CKIT	PUM33SKIT
	PUM43CKIT	PUM43SKIT
	PUM53CKIT	PUM53SKIT

BAG FOR NEW OR BACKSIDE VISUALS

Accessory for Pop-Up Magnetic



- IT**
- Borsa per tubo extra per proteggere le grafiche
- ES**
- Bolsillo extra para proteger la impresión
- FR**
- Sac tubulaire supplémentaire pour protéger le visuel

Art. nr.	PUM-BAGV7
	PUM-BAGV5B

TABLE TOP

Accessory for Pop-Up Magnetic Hard Case



- IT**
- Espositore da tavolo disponibile in 4 colori
- ES**
- Tablero disponible en 4 colores
- FR**
- Plateau de table disponible en 4 couleurs

Art. nr.	PUMTTB	●
	PUMTTW	●
	PUMTTS	●
	PUMTTWH	○

EXTENSION KIT FOR BACKSIDE

Accessory for Pop-Up Magnetic



- IT**
- Barra magnetica con nastro magnetico a 5 pali
- ES**
- Barra magnética con cinta magnética de 5 polos
- FR**
- Barre magnétique avec ruban magnétique à 5 pôles

Art. nr.	PUM33CE	PUM33SE
	PUM43CE	PUM43SE
	PUM53CE	PUM53SE

custom sizes available

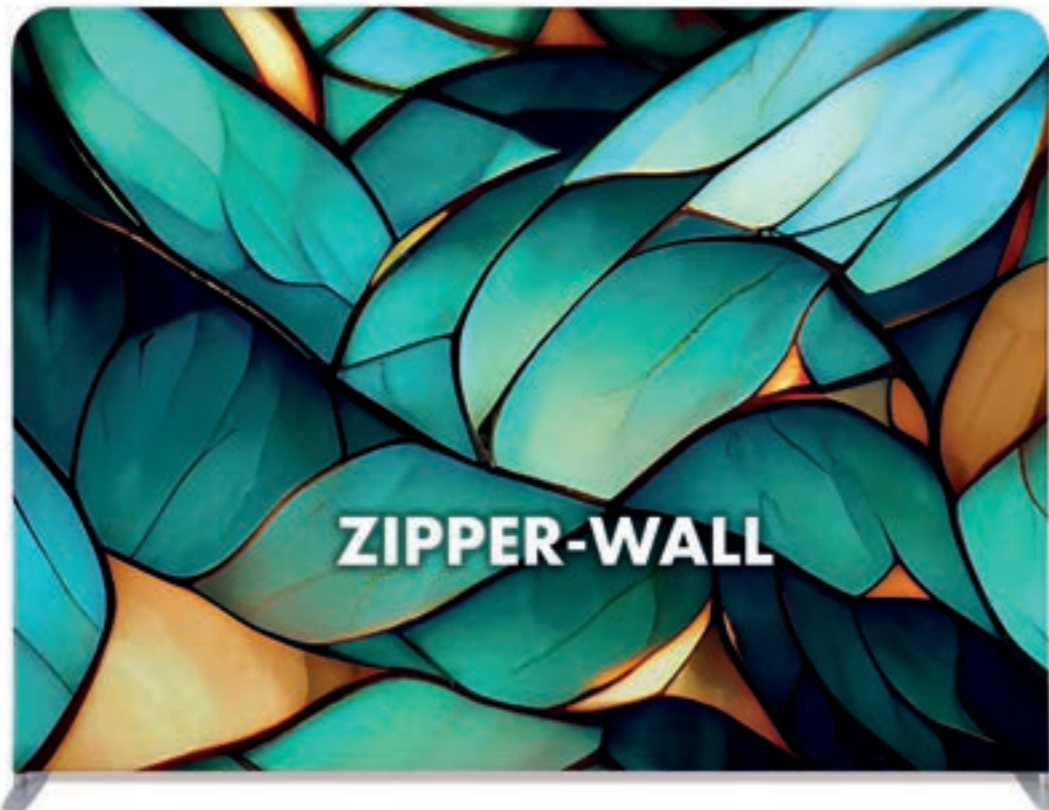

ZIPPER-WALL CONNECTOR

Accessory for Zipper-Wall Straight Basic

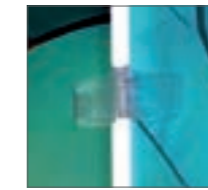

- IT • Angolazione fino a 180 gradi
- ES • Ángulo de hasta 180 grados
- FR • Angle jusqu'à 180 degrés

Art. nr. ZW-CON

ZIPPER-WALL STRAIGHT BASIC

- IT • Telaio classico da 32 mm per fare un'ottima impressione
• Installazione facile e veloce grazie al montaggio senza utensili
• Per utilizzo monofacciale o bifacciale
- ES • Marco clásico de 32 mm para causar una gran impresión
• Montaje fácil y rápido, ya que se trata de un sistema de montaje sin necesidad de herramientas
• Para el uso a una o a doble cara
- FR • Cadre classique de 32 mm pour une forte impression
• Montage facile et rapide grâce à l'assemblage sans outils
• Pour une utilisation simple ou double-face



Art. nr.	Dimensions (cm)			
	W	H	D	KG
ZWSE150-150	150	150	45	9,7
ZWSE200-150	200	150	45	10,1
ZWSE100-230	100	230	45	10
ZWSE150-230	150	230	45	10
ZWSE200-230	200	230	45	10,7
ZWSE250-230	250	230	45	12,2
ZWSE300-230	300	230	45	12,5
ZWSE400-230	400	230	45	15,7
ZWSE200-250	200	250	45	11,5
ZWSE200-300	200	300	45	12,3

- ⊕ Custom sizes and projects are available on request (European Production)
- ⊕ Including Luxurious Soft Carry Bag
- ⊕ Optional: Upgrade with the Luxurious Padded Trolley Bag as accessory
- ⊕ Optional: Zipper-Wall Connector (see p. 271), LED Lighting and Clamp Tube (see p. 277)





ZIPPER-WALL STRAIGHT

- IT**
- Telaio tubolare in alluminio leggero da 34 mm
 - Per utilizzo monofacciale o bifacciale
 - Espositore con cerniera da parete Premium con trolley imbottito prestigioso
- ES**
- Ligero marco de aluminio tubular de 34 mm
 - Para uso de una o dos caras
 - Premium Zipper-Wall con Lujosa Bolsa Acolchada con Ruedas
- FR**
- Cadre tubulaire léger de 34 mm en aluminium
 - Pour une utilisation simple ou double-face
 - Zipper-Wall de qualité supérieure avec luxueux sac à roulette rembourré

Art. nr.	Dimensions (cm)			
	W	H	D	KG
ZWS100-230	100	230	45	10,7
ZWS150-230	150	230	45	10,7
ZWS200-230	200	230	45	11,3
ZWS250-230	250	230	45	12,9
ZWS300-230	300	230	45	13,3
ZWS400-230	400	230 <td 45	16,6	
ZWS500-230	500	230	45	17,8
ZWS600-230	600	230	45	18,6
ZWS200-250	200	250	45	12,1

Optional: LED Lighting and Clamp Tube (see p. 277)



ZIPPER-WALL CURVED

- IT**
- Telaio tubolare in alluminio leggero
 - Il più famoso Espositore con cerniera da parete con una curva regolabile
 - Duraturo e facile da usare
- ES**
- Estructura ligera de aluminio tubular
 - La Zipper Wall más popular con una curva suave
 - Duradero y fácil de usar
- FR**
- Cadre tubulaire léger en aluminium
 - Le Zipper-Wall le plus populaire avec une courbe douce
 - Durable et facile à utiliser

Art. nr.	Dimensions (cm)			
	W	H	D	KG
ZWC300-230	300	230	60	10,4
ZWC400-230	400	230	80	11,4
ZWC500-230	500	230	100	14

Optional: LED Lighting and Clamp Tube (see p. 277)



NEW



TEXTILE FRAME TOWER

- IT**
 - Espositore a torre a quattro lati
 - Un'attrazione per gli spazi pubblici
 - Leggero ma robusto
- ES**
 - Expositor a cuatro caras
 - Espectacular para espacios públicos
 - De estructura ligera pero robusta
- FR**
 - Tour de présentation à quatre faces
 - Un coup de cœur dans les espaces publics
 - Léger, mais robuste



Art. nr.	DIN/Size	Dimensions (cm)			
		W	H	D	KG
TFRTOWER60x200	60 x 200	60	200,8	66	10,5
TFRTOWER85x200	85 x 200	85	200,8	91	10,9
TFRTOWER100x200	100 x 200	100	200,8	106	11,4

Other sizes and profile depths available on request



FLEX WALL

- IT**
 - Regolabile in altezza e ampiezza con pali telescopici
 - Sistema leggero, facile da trasportare e spostare
 - Una grande parete pubblicitaria adatta a ogni budget
- ES**
 - Su altura y su anchura son ajustables gracias a los postes telescópicos
 - Un sistema ligero, fácil de transportar y manipular
 - Una gran pared para sus anuncios perfecta para cualquier presupuesto
- FR**
 - Réglable en hauteur et en largeur grâce aux piquets télescopiques
 - Système léger, simple à transporter et à déplacer
 - Une super paroi de fond publicitaire, adaptée à tous les budgets



Art. nr.	Dimensions (cm)			
	W	H	D	KG
FLW-M	250	250	44	5
FLW-L	312	250,5	44	6,7



Graphic sizes M: Width 175 - 240 cm. Height 100 - 240 cm
 Graphic sizes L: Width 175 - 300 cm. Height 100 - 240 cm



FENCE BANNER

- IT**
 - Banner pubblicitario in tessuto adatto al fissaggio su muro, edifici e recinzioni
 - Impatto elevato e in varie misure
 - Grafica a sublimazione stabile con occhielli in plastica trasparente
- ES**
 - Banner de tela para anuncios apto para ser colgado en la pared, en la fachada de un edificio o en una valla
 - Gran impacto con varios tamaños
 - Estable gráfica impresa por sublimación con arandelas de plástico transparente
- FR**
 - Bannière publicitaire en tissu pour l'extérieur pouvant être fixée aux murs, aux bâtiments et aux clôtures
 - Impact élevé avec différentes tailles
 - Graphique stable avec impression par sublimation avec œillets en plastique transparent



Art. nr.	Dimensions (cm)			
	W	H	D	KG
FBG150-100	150	100	0,2	0,3
FBG200-100	200	100	0,2	0,4
FBG300-100	300	100	0,2	0,5
FBG200-140	200	140	0,2	0,5
FBG300-140	300	140	0,2	0,8
FBG400-140	400	140	0,2	1



Including mounting strips
 Other sizes are available on request



WALL LED 50

Accessory for every Pop-Up and on several exhibitions stands



- IT** • Include connettori Telaio e Pop-Up
- ES** • Incluye los conectores del pop-up y la estructura
- FR** • Inclus clips pop-up et flex frame

Art. nr. WLED50B ●
 WLED50S ●
 WLED50WH ○

Y-CABLE

Accessory for WLED50



- IT** • Cavo a Y collega 2 WLED 50
- ES** • Cable-Y conecta 2 WLED 50
- FR** • Cable-Y permettant de connecter 2 WLED 50

Art. nr. WLEDY

WALL LED 116

Accessory for every Pop-Up and on several exhibitions stands



- IT** • Include connettori Telaio e Pop-Up
- ES** • Incluye los conectores del pop-up y la estructura
- FR** • Clips pop-up et flex frame inclus

Art. nr. Power plug backside
 WLED116B-BACK ●
 WLED116S-BACK ●
 Power plug left & right side
 WLED116B-SIDE ●
 WLED116S-SIDE ●

LUXURIOUS LIGHT BAG

Accessory for WLED50 and WLED116



- IT** • Adatto ad alloggiare 3 luci
- ES** • Apto para almacenar 3 luces
- FR** • Convient pour stocker 3 lumières

Art. nr. L-BAG-M (WLED50)
 L-BAG-L (WLED116)

WALL LIGHT CLAMP TUBE

Accessory for every Zipper-Wall



- IT** • Collare per tubi adatto a tubi con Ø 30 - 34 mm
- ES** • Adecuado para tubos de Ø 30 - 34 mm
- FR** • Collier de serrage pour tubes d'un Ø de 30 à 34 mm

Art. nr. WLCTB ●
 WLCTS ●
 WLCTWH ○

WALL LIGHT CLAMP WALL

Accessory for exhibitions stands



- IT** • Collare da parete fino a un massimo di 53 mm
- ES** • Abrazadera para paredes de un máximo de 53 mm
- FR** • Fixation murale jusqu'à 53 mm max

Art. nr. WLCWB ●
 WLCWS ●
 WLCWWH ○

19. TENTS

Tende
Carpas
Tentes

Draw attention, spark interests, claim the location and advertise with an impressive tent! Ideal for any outdoor event or promotion. Perfect for a variety of settings from trade shows to outdoor events and promotions, from public centres to entrances. Easy to set up and available in various sizes and with many configuration possibilities.

INDEX

19.1 Tents and
Accessories **278**
Tende e accessori
Carpas y Accesorios
Tentes et Accessoires

- ✦ WEATHER RESISTIBLE SIGNAGE
- ✦ PORTABLE OUTDOOR PRODUCTS, SO YOU CAN EASILY TAKE THEM FROM EVENT TO EVENT
- ✦ GRAPHIC AVAILABLE TO CUSTOMISE YOUR OUTDOOR PRODUCT



TENT STEEL

- IT**
- Tubi quadri arrotondati da 30 mm verniciati in bianco
 - Grandi bottoni a pressione per un rapido montaggio
 - Tenda in acciaio di alta qualità con borsa per il trasporto

- ES**
- Los tubos cuadrados y redondeados de 30 mm revestidos en blanco
 - Botones grandes y fáciles de pulsar para su rápida instalación
 - Carpa de Acero Premium con una bolsa transportadora

- FR**
- Tubes carrés arrondis à revêtement blanc de 30 mm
 - Grands boutons poussoirs faciles à utiliser pour une installation rapide
 - Tente en acier de qualité supérieure avec sac de transport



Art. nr.	Dimensions (cm)			
	W	H	D	KG
TS3B	290	342	290	19
TS4,5	449	342	290	23

- 📦 Including bag and stake kit
- 🚫 Canopy not included



CANOPY

Accessory for Tent Steel



- IT** • Impermeabile grazie alla cucitura sigillata
- ES** • Resistente al agua gracias a su la costura cosida sellada
- FR** • Imperméable grâce à la couture cousue scellée

Art. nr. TS3CAN-G Full Colour 3x3 m
 TS4,5CAN-G Full Colour 3x4,5 m
 TS3CAN-GWH White 3x3 m
 TS4,5CAN-GWH White 3x4,5 m

FULL WALL

Accessory for Tent Steel



- IT** • Grafica tessuto a colori con cinghie in velcro per fissare la grafica ai montanti del gazebo
- ES** • La gráfica de tela a todo color con tiras de velcro para asegurar su colocación junto a las patas de la carpa
- FR** • Visuel en tissu coloré avec des bandes de velcro pour le fixer aux piquets de la tente

Art. nr. TS3-GWI Inside 3x3 m
 TS4,5-GWI Inside 3x4,5 m
 TS3-GWO Outside 3x3 m
 TS4,5-GWO Outside 3x4,5 m
 TS3-GWDS Double-Sided 3x3 m
 TS4,5-GWDS Double-Sided 3x4,5 m

HALF WALL

Accessory for Tent Steel



- IT** • Grafica tessuto a colori con cinghie in velcro per fissare la grafica ai montanti del gazebo
- ES** • La gráfica de tela a todo color con tiras de velcro para asegurar su colocación junto a las patas de la carpa
- FR** • Visuel en tissu coloré avec des bandes de velcro pour le fixer aux piquets de la tente

Art. nr. TS3-GHW Single-Sided 3x3 m
 TS4,5-GHW Single-Sided 3x4,5 m
 TS3-GHWDS Double-Sided 3x3 m
 TS4,5-GHWDS Double-Sided 3x4,5 m

CONNECTOR

Accessory for Tent Steel



- IT** • Durable, weather-resistant clamps that connects two tents together
- ES** • Abrazaderas duraderas y resistentes a la intemperie que conectan dos carpas juntas
- FR** • Pincas solides et résistantes aux intempéries pour interconnecter deux tentes

Art. nr. TS-CON

FLAG HOLDER SET

Accessory for Tent Steel



- IT** • Morsetti durevoli e resistenti alle intemperie che permettono alla bandiera di ruotare in base al vento
 - ES** • Abrazaderas duraderas y resistentes a la intemperie que permiten que la bandera gire con el viento
 - FR** • Solides pincas résistantes aux intempéries qui permettent au drapeau de tourner dans le vent
- Art. nr.** TSFH-17

✚ Connector for Beach Flag Budget Small and Medium. See chapter 16. Flags (p. 236 - 237)

HALF WALL SUPPORT BAR

Accessory for Tent Steel



- IT** • Barra di supporto in acciaio e morsetti per grafica gazebo a mezza parete
- ES** • Barra de soporte de acero y abrazaderas para gráfico de carpa de media pared
- FR** • Barre de support en acier et pincas pour visuel de tente à demi-paroi

Art. nr. TS3-HWB Half Wall Support Bar 3x3 m
 TS4,5-HWB Half Wall Support Bar 3x4,5 m

STEEL PLATE 5 KG

Accessory for Tent Steel



- IT** • Peso d'acciaio resistente per fissaggio ai montanti del gazebo
- ES** • Peso de acero resistente para sujetar a las patas de la carpa
- FR** • Poids en acier résistant pour la fixation aux pieds de la tente

Art. nr. TS-ST5

STAKE KIT

Accessory for Tent Steel

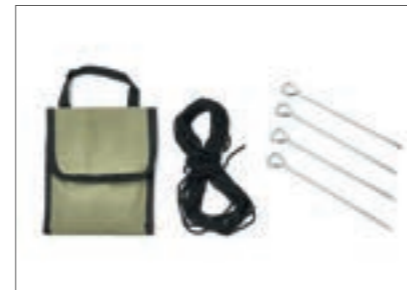

- IT** • Set da 4 picchetti e 4 corde in poliestere per un fissaggio più sicuro del gazebo
- ES** • Juego de 4 estacas de tierra y 4 cuerdas de poliéster, para la fijación adicional de la carpa
- FR** • Jeu de 4 piquets de sol et de 4 cordes en polyester, pour une fixation plus sûre de la tente

Art. nr. TS-SK

SAND BAG

Accessory for Tent Alu and Tent Steel



- IT** • Perfetta per migliorare la stabilità dei Gazebo
- ES** • Perfecto para mejorar la estabilidad de las Carpas
- FR** • Parfait pour améliorer la stabilité des tentes

Art. nr. T-SB

HEAVY DUTY STAKE KIT

Accessory for Tent Alu and Tent Steel



- IT** • Set da 4 picchetti e 4 corde in poliestere per un fissaggio più sicuro del gazebo
- ES** • Juego de 4 estacas de tierra y 4 cuerdas de poliéster, para la fijación adicional de la carpa
- FR** • Jeu de 4 piquets de sol et de 4 cordes en polyester, pour une fixation plus sûre de la tente

Art. nr. T-SK-HD

PATENTED



TENT ALU

- IT**
- Tubi esagonali in alluminio lucido da 40 mm
 - Piedini rotondi brevettati che facilitano lo spostamento della tenda
 - Tenda resistente in alluminio con borsa da trasporto a rotelle

- ES**
- Tubos lisos hexagonales de aluminio de 40 mm
 - Patas redondas y patentadas para facilitar la movilidad de la Carpa
 - Carpa de aluminio sólida viene con una bolsa transportadora con ruedas

- FR**
- Tubes hexagonaux en aluminium lisse de 40 mm
 - Pieds ronds brevetés qui facilitent le déplacement de la tente
 - Solide tente en aluminium avec sac de transport à roulettes



Art. nr.	Dimensions (cm)			
	W	H	D	KG
TA3	300	342	300	20
TA4,5	300	342	450	25
TA6	300	342	600	32

*Set in 2 boxes

- 📦 Including bag and stake kit
- 🚫 Canopy not included



CANOPY

Accessory for Tent Alu



- IT** • Impermeabile grazie alla cucitura sigillata
- ES** • Resistente al agua gracias a su la costura cosida sellada
- FR** • Imperméable grâce à la couture cousue scellée

Art. nr. T3CAN-G Full Colour 3x3 m
 T4,5CAN-G Full Colour 3x4,5 m
 T6CAN-G Full Colour 3x6 m
 T3CAN-GWH White 3x3 m
 T4,5CAN-GWH White 3x4,5 m
 T6CAN-GWH White 3x6 m

FULL WALL

Accessory for Tent Alu



- IT** • Grafica in poliestere duratura con cinghie in velcro per fissare la grafica ai montanti del gazebo
- ES** • Gráfico de poliéster duradero con tiras de velcro para asegurar la impresión en las patas de la carpa
- FR** • Graphique en polyester durable avec bandes velcro pour fixer l'impression aux pieds de la tente

Art. nr. T3-GWI Inside 3x3 m
 T4,5-GWI Inside 3x4,5 m
 T6-GWI Inside 3x6 m
 T3-GWO Outside 3x3 m
 T4,5-GWO Outside 3x4,5 m
 T6-GWO Outside 3x6 m
 T3-GWDS Double-Sided 3x3 m
 T4,5-GWDS Double-Sided 3x4,5 m
 T6-GWDS Double-Sided 3x6 m

HALF WALL

Accessory for Tent Alu



- IT** • Grafica in poliestere duratura con cinghie in velcro per fissare la grafica ai montanti del gazebo
- ES** • Gráfico de poliéster duradero con tiras de velcro para asegurar la impresión en las patas de la carpa
- FR** • Graphique en polyester durable avec bandes velcro pour fixer l'impression aux pieds de la tente

Art. nr. T3-GHW Single-Sided 3x3 m
 T4,5-GHW Single-Sided 3x4,5 m
 T3-GHWDS Double-Sided 3x3 m
 T4,5-GHWDS Double-Sided 3x4,5 m

HALF WALL SUPPORT BAR

Accessory for Tent Alu



- IT** • Barra di supporto in acciaio e morsetti per grafica gazebo a mezza parete
- ES** • Barra de soporte de aluminio y abrazaderas para gráfico de carpa de media pared
- FR** • Barre de support en aluminium et pinces pour visuel de tente à demiparoi

Art. nr. TA3-HWB Half Wall Support Bar 3x3 m
 TA4,5-HWB Half Wall Support Bar 3x4,5 m

CONNECTOR

Accessory for Tent Alu



- IT** • Morsetti durevoli e resistenti alle intemperie che collegano due gazebo insieme
- ES** • Abrazaderas duraderas y resistentes a la intemperie que conectan dos carpas juntas
- FR** • Pincas solides et résistantes aux intempéries pour interconnecter deux tentes

Art. nr. TA-CON

STEEL PLATE 5 KG

Accessory for Tent Alu



- IT** • Peso d'acciaio resistente per fissaggio ai montanti del gazebo
- ES** • Peso de acero resistente para sujetar a las patas de la carpa
- FR** • Poids en acier résistant pour la fixation aux pieds de la tente

Art. nr. TA-ST5

STAKE KIT

Accessory for Tent Alu



- IT** • Set da 4 picchetti e 4 corde in poliestere per un fissaggio più sicuro del gazebo
- ES** • Juego de 4 estacas de tierra y 4 cuerdas de poliéster, para la fijación adicional de la carpa
- FR** • Jeu de 4 piquets de sol et de 4 cordes en polyester, pour une fixation plus sûre de la tente

Art. nr. TA-SK

FLAG HOLDER SET

Accessory for Tent Alu



- IT** • Morsetti durevoli e resistenti alle intemperie che permettono alla bandiera di ruotare in base al vento
- Set di 2 supporti bandiera per un rotatore da 17 mm
- ES** • Abrazaderas duraderas y resistentes a la intemperie que permiten que la bandera gire con el viento
- Set de 2 portabanderas para rotador de 17 mm
- FR** • Solides pinces résistantes aux intempéries qui permettent au drapeau de tourner dans le vent
- Jeu de 2 porte-drapeaux pour rotateur de 17 mm

Art. nr. TAFH-17

☛ Connector for Beach Flag Budget Small and Medium. See chapter 16. Flags (p. 236 - 237)

SAND BAG

Accessory for Tent Alu and Tent Steel



- IT** • Morsetti durevoli e resistenti alle intemperie che collegano due gazebo insieme
- ES** • Perfecto para mejorar la estabilidad de las Carpas
- FR** • Parfait pour améliorer la stabilité des tentes

Art. nr. T-SB

HEAVY DUTY STAKE KIT

Accessory for Tent Alu and Tent Steel



- IT** • Perfetta per migliorare la stabilità dei Gazebo
- ES** • Juego de 4 estacas de tierra y 4 cuerdas de poliéster, para la fijación adicional de la carpa
- FR** • Jeu de 4 piquets de sol et de 4 cordes en polyester, pour une fixation plus sûre de la tente

Art. nr. T-SK-HD



Latex Graphic

We print with professional printer:
HP LATEX570

1,60 m
maximum
width

Latex print is a high quality print technology that uses water based inks and offers great printing and colour quality. Prints are environmental friendly and Latex print technology allows quick delivery without quality compromises.

Most commonly used for: **Posters for A-Boards, Poster Frames and LED Frames. Prints for Roll-Banners and Stickers (Adhesive Foil branding).**

FILES WE WORK WITH

VECTOR:

PDF
EPS
AI

RASTER*:

PDF
TIFF
JPG
PSD

*Only use large, high quality files for raster print



POSTERS

- 135 g/m² Premium Poster Paper
- 220 g/m² Standard Multi Layer
- 285 g/m² Poster Backlit



ROLL-BANNERS

- 220 g/m² Standard Multi Layer
- 265 g/m² Opaque Fabric
- 510 g/m² Symbio Banner



STICKERS

- 140 g/m² Adhesive Foil

Dye Sublimation Graphic

We print with professional printers:
HP Stitch S500 and HP Stitch S1000

3,20 m
maximum
width

Sublimation print is used for polyester based graphics where the ink sublimates into fabric fibres after the fabric is pressed inside the heat press. Offers great print quality and durability with reasonable lead times.

Most commonly used for: **Zipper-Walls, Counters, Table Covers, Pop-Up Impress, Flags, Tents and SEG products.**



FLAGS

- 110 g/m² Flag (Direct)
- 120 g/m² Silverback (Direct)
- 110 g/m² Wind Green



ZIPPER-WALLS, POP-UP WALLS & SEG

- 180 g/m² Starlight
- 195 g/m² Samba
- 230 g/m² Soft Knit
- 190 g/m² Lumina
- 200 g/m² Expendable Green



TABLE COVERS & COUNTERS

- 170 g/m² Poplin
- 280 g/m² Double Stretch



TENTS

- 280 g/m² Full Colour

why latex graphic?

- High resolution print technology
- Water based inks certified ECO 14142007
- Efficient printing times and great colour quality
- Quick production process with fast ink drying
- B1 fire rated materials marked
- Water resistant materials with icon
- Allows outdoor use with most print media

Green solutions: PVC Free print materials



- Premium Poster Paper
- Opaque Fabric

Choose for ecological posters with the pure paper with the Premium Poster Paper. This print material is made from cellulose fibres derived from wood). Or go for a Roll-Banner promotion without any PVC! For both prints we use water-based, UL ECOLOGO® UL 2801 certified Latex inks.

why dye sublimation graphic?

- For Polyester based fabric graphics
- Environmental friendly water based inks
- Ink sublimates into fabric fibres
- Direct print or transfer print
- Great printing and colour quality
- Quick production processes
- Most print materials are B1 rated
- Water resistant materials with icon

Green solutions: Eco print materials

(recognisable by eco-label on the graphic)



- Wind Green
- Expendable Green

With love for the world and environment you can choose for Eco Dye Sublimation graphics on recycled print material. Next to that, water-bases inks are being used. Wave your Beach Flag or promote your Zipper-Banner Slim in eco prints! For both prints we use water-based, ECO PASSPORT certified Dye Sublimation inks. All the same great quality, only with a little extra love for the environment.





**7a rue de Bitbourg
L-1273 Luxembourg Hamm**

+352 48 26 36 72

ifp@reka.lu

www.reka-lfp.lu